

MORE CHOICE THAN EVER

- Tube inserts in various shapes, materials, colours, finishes to match your specification
- Threaded, ribbed or notched for easy fitting
- Protect floor surfaces and maintain design aesthetics with load bearing glides for both round and square tubing

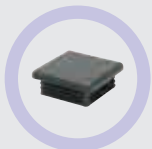

FREE
SAMPLES



718



723



724



727



731



739



740



746



750



756

MORE THAN
2,000
TUBE INESRTS,
CONNECTORS
AND FERRULES
PRODUCTS
AVAILABLE

TUBE INSERTS, CONNECTORS AND FERRULES



TUBE INSERTS

718



THREADED INSERTS

743



TUBE CONNECTORS

750



FERRULES

754



TUBE LOCKS

757

TUBE INSERTS

Your Guide To Finding the right Tube Gauge size:

Tube Gauge Calculation

- Metal tubes are available in various tube gauges, although the most commonly used in furniture manufacture range from 10 to 20 gauge.
- To use this guide, calculate the wall thickness of the tube by subtracting the inside diameter from the outside diameter and dividing by 2. By cross-referencing this wall thickness on the table right, the tube gauge is obtained.

Gauge	Wall Thickness*		Gauge	Wall Thickness*	
	inches	(mm)		inches	(mm)
10	0.128	3.25	17	0.056	1.42
11	0.116	2.95	18	0.048	1.22
12	0.104	2.64	19	0.040	1.02
13	0.092	2.34	20	0.036	0.91
14	0.080	2.03	21	0.032	0.81
15	0.072	1.83	22	0.028	0.71
16	0.064	1.63	-	-	-

* Remember the lower the gauge the thicker the wall thickness

Ribbed Square Inserts

SR 1540

Black and White LDPE

- Ribbed for easy assembly and secure fitting
- Cover sharp tube edges

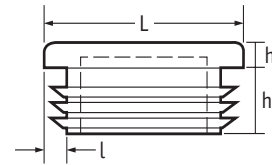

Part Number				Dimensions						StandardPack Quantity
Black		White		L (mm)	L (ins)	h (mm)	h1 (mm)	l (mm)	l (gauge)	
Polished	Eroded	Polished	Eroded							
-	-	-	056010060303	10	-	4	11.5	1.5-2.0	-	500
-	460689	-	-	12	-	4	11.5	1.5-2.0	-	2500
-	056012069903	-	056012060303	12	-	2	7	1.0-2.0	-	500
111193	111211	111229	111247	12.7	½	4	11.5	0.8-2.0	14-20	2500
111194	-	-	111248	13	-	5	11.5	0.8-2.0	-	2500
111501	111539	-	111615	15	-	4	11.5	0.8-2.0	-	2000
-	056015069903	-	056015060303	15	-	3	13	1.0-2.0	-	500
111195	111213	111231	111249	16	⅝	5	11.5	0.8-2.5	12-20	2500
11764	-	-	-	18	-	5	16.5	1.2-1.5	-	5000
-	056018069903	-	056018060303	18	-	5	12	1.0-2.0	-	500
111196	111214	111232	-	19	¾	5	11.5	0.8-2.5	10-12	2500
111197	111215	111233	111251	20	-	5	11.5	0.8-2.5	-	2500
-	056020069903	-	056020060303	20	-	5	11.5	1.5-2.0	-	100
111198	111216	-	111252	22	⅞	5	11.5	0.8-2.5	10-12	2500
-	056022069903	-	056022060303	22	-	5	11.5	1.0-3.5	-	100
111199	111217	111235	-	25	-	5	11.5	1.0-2.5	-	2500
-	056025069903	-	056025060303	25	-	6	12	1.5-2.0	-	100
111200	111218	111236	111254	25.4	1	5	11.5	1.0-2.5	12-20	2500
199149	-	199150	-	28.6	1⅜	5	12.4	1.0-2.0	16-20	2000
111201	111219	111237	-	30	-	5	11.5	1.0-3.0	-	2000
-	056030069903	-	056030060303	30	-	6	12	1.5-2.0	-	100
111502	111540	-	111616	32	1¼	5	11.5	1.0-3.0	10-18	1500
-	056032069903	-	-	32	-	5	11.5	1.0-3.5	-	50
111202	111220	111238	-	35	1⅜	5	11.5	1.0-3.0	10-18	1500
-	056035069903	-	056035060303	35	-	5	14.5	1.0-3.0	-	50
111503	111541	111579	111617	38	1½	5	14.5	1.0-3.0	10-18	1000

CONTINUED ON NEXT PAGE

Ribbed Square Inserts *CONTINUED*

SR 1540

Black and White LDPE

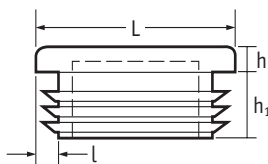

Part Number				Dimensions						Standard Pack Quantity
Black		White		L (mm)	L (ins)	h (mm)	h1 (mm)	l (mm)	l (gauge)	
Polished	Eroded	Polished	Eroded							
111203	111221	111239	111257	40	-	5	14.5	1.0-3.0	-	500
199188	-	-	-	44.4	1¾	4.7	15.7	1.0-2.0	14-18	500
199187	-	-	-	44.4	1¾	4.7	15.1	2.0-3.0	10-14	500
111204	111222	-	056045060303	45	-	5	14.5	1.0-3.0	-	500
111205	111223	-	-	50	-	5	14.5	1.0-3.0	-	500
-	199274	199868	-	50	-	6.6	18	3.0-5.0	-	500
-	056050069903	-	056050060303	50	-	5	20	1.5-4.0	-	50
111206	111224	111242	111260	50.8	2	5	14.5	1.0-3.0	10-18	500
-	466560	-	056055060303*	55	-	5	14.5	2.0-4.0	-	400
111810	111811	-	111813	60	-	5	24.3	3.0-4.0	-	250
111207	111225	111243	111261	60	2½	5	14.5	1.0-3.0	-	250
111504	111542	-	111618	63.5	-	6	14.5	1.0-3.0	11-20	250
111505	111543	-	111619	65	-	6	14.5	1.0-3.0	-	250
111208	111226	111244	-	70	-	6	22	2.0-4.0	-	150
-	056070069903	-	056070060303	70	-	5	18.5	2.0-4.0	-	10
111506	111544	-	111620	75	-	6	22	2.0-4.0	-	200
111507	111545	-	111621	76.2	3	6	22	2.0-4.0	8.4	200
111209	111227	-	111263	80	-	6	22	2.0-4.0	-	150
-	056080069903	-	056080060303	80	-	8	24	3.0-5.0	-	10
-	460699	-	-	90	-	6	21	3.0-5.0	-	100
111210	111228	111246	-	100	-	7	22	2.0-4.0	-	100
-	056100069903	-	056100060303	100	-	7	24	2.0-4.0	-	10
-	460700	-	-	110	-	6	24.5	3.5-0-5.0	-	60
-	056110069903	-	056110060303	110	-	6	24.5	3.0-5.0	-	10
-	466558	-	056120060303	120	-	5	25	2.5-5.0	-	100
-	056140069903	-	056140060303	140	-	6	35	4.0-7.0	-	10
-	466559	-	-	150	-	7	27	5.0-8.0	-	75

*Pack Qty = 25

Ribbed Square Inserts

SR 1540

Mid and Dark Grey

- Mid Grey similar to RAL 7042
- Dark Grey similar to RAL 7011

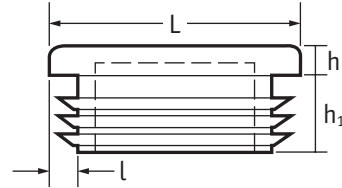

Part Number				Dimensions						Standard Pack Quantity
Mid Grey		Dark Grey		L (mm)	L (ins)	h (mm)	h1 (mm)	l (mm)	l (gauge)	
Polished	Eroded	Polished	Eroded							
-	056012062003	-	-	12	-	2	7	1.0-2.0	-	500
111265	-	-	-	12.7	½	4	11.5	0.8-2.0	14-20	2500
-	056013062003	-	-	13	-	4	11.5	1.5-2.0	-	500
-	111691	-	111767	15	-	4	11.5	0.8-2.0	-	2000
-	056015062003	-	-	15	-	3	13	1.0-2.0	-	500
111267	111285	-	-	16	⅝	5	11.5	0.8-2.5	12-20	2500
-	056018062003	-	-	18	-	5	12	1.0-2.0	-	500
111268	111286	111304	111322	19	¾	5	11.5	0.8-2.5	10-12	2500
-	111287	-	111323	20	-	5	11.5	0.8-2.5	-	2500
-	056020062003	-	-	20	-	5	11.5	1.5-2.0	-	100
-	111288	-	111324	22	⅞	5	11.5	0.8-2.5	10-12	2500
-	056022062003	-	-	22	-	5	11.5	1.0-3.5	-	100
-	111289	-	111325	25	-	5	11.5	1.0-2.5	-	2500
-	056025062003	-	-	25	-	6	12	1.5-2.0	-	100
111272	111290	111308	111326	25.4	1	5	11.5	1.0-2.5	12-20	2500
-	111291	-	111327	30	-	5	11.5	1.0-3.0	-	2000
-	056030062003	-	-	30	-	6	12	1.5-2.0	-	100
-	111692	-	111768	32	1¼	5	11.5	1.0-3.0	10-18	1500
-	056032062003	-	-	32	-	5	11.5	1.0-3.5	-	50
-	056035062003	-	-	35	-	5	14.5	1.0-3.0	-	50
111655	111693	-	111769	38	1½	5	14.5	1.0-3.0	10-18	1000
-	111293	-	111329	40	-	5	14.5	1.0-3.0	-	500
110646	-	-	-	44.4	1¾	4.7	15.1	2.0-3.0	10-14	500
111276	111294	-	111330	45	-	5	14.5	1.0-3.0	-	500
111277	111295	111313	111331	50	-	5	14.5	1.0-3.0	-	500
-	056050062003	-	-	50	-	5	20	1.5-4.0	-	50
-	111296	-	-	50.8	2	5	14.5	1.0-3.0	10-18	500
-	056055062003	-	-	55	-	5	14.5	2.0-4.0	-	25
111814	111815	111816	111817	60	-	5	24.3	3.0-4.0	-	250
-	111694	-	-	63.5	2	6	14.5	1.0-3.0	11-20	250
-	111695	-	111771	65	-	6	14.5	1.0-3.0	-	250
-	056070062003	-	-	70	-	5	18.5	2.0-4.0	-	10
-	111696	-	111772	75	-	6	22	2.0-4.0	-	200
-	111697	-	111773	76.2	3	6	22	2.0-4.0	8-14	200
-	056080062003	-	-	80	-	8	24	3.0-5.0	-	10
-	056090062003	-	-	90	-	7	25	3.5-5.0	-	10
-	056100062003	-	-	100	-	7	24	2.0-4.0	-	10
-	056110062003	-	-	110	-	6	24.5	3.0-5.0	-	10
-	056120062003	-	-	120	-	5	25	2.5-5.0	-	10
-	056140062003	-	-	140	-	6	35	4.0-7.0	-	10

Coloured Square Inserts

SR 1540

LDPE - Various Colours

- Eroded Head
- Ideal for educational or play equipment



Part Number					Dimensions			Standard Pack Quantity
Yellow	Red	Green	Blue	Brown	L (mm)	L (ins)	l (mm)	
111844	111845	111846	111847	111848	19.0	¾	0.8 - 2.5	2500
111871	111872	111873	111874	111875	20.0	-	0.8 - 2.5	2500
111877	111878	111879	111880	111881	25.0	-	1.0 - 2.5	2500
111901	111902	111850	805270	111851	25.4	1	1.0 - 2.5	2500

Square Load Bearing Glides

SR 1630

Black ABS unless otherwise stated

- Suitable for light and heavy-duty applications
- Step lead provides easy installation
- Press fit assures a secure hold in tubing



Part Number	Dimensions				Standard Pack Quantity
	Tube OD (mm)	Wall Thickness (mm)	Tube OD (ins)	Wall Thickness (gauge)	
SIG1100A	9.5	1.7	0.375	16	5000
SIG1105A	9.5	1.1	0.375	19	5000
SIG1108A	12.7	2.1	0.5	14	4000
SIG1110A	12.7	1.7	0.5	16	15000
SIG1115A	12.7	1.2	0.5	18	15000
SIG1120A	15.9	1.7	0.625	16	8000
SIG1125A	15.9	1.5	0.625	17	8000
SIG1130A	15.9	1.2	0.625	18	8000
SIG1135A	15.9	0.9	0.625	20	8000
SIG1140A	17.7	1.2	0.695	18	5000
SIG1145A	18.2	1.2	0.715	18	5000
SIG1150A	18.4	3	0.725	11	5000
SIG1155A	18.4	1.7	0.725	16	5000
SIG1160A	19.1	3	0.75	11	5800
SIG1165A	19.1	2.4	0.75	13	6000
SIG1170A	19.1	1.8	0.75	15	4000
SIG1175A	19.1	1.7	0.75	16	5500
SIG1180A	19.1	1.2	0.75	18	5500
SIG1185A	19.1	1.1	0.75	19	5500
SIG1190A	19.1	0.9	0.75	20	5500
SIG1200A	20.6	2.1	0.812	14	4500
SIG1205A	20.6	1.7	0.812	16	4500
SIG1210A	20.6	1.2	0.812	18	4500
SIG1215A	22.2	3	0.875	11	5000
SIG1220C	22.2	1.7	0.875	16	4000
SIG1225A	22.2	1.2	0.875	18	4000
SIG1235A	25.4	3	1	11	3200
SIG1240A	25.4	2.1	1	14	3000
SIG1244C*	25.4	1.7	1	16	2800

Part Number	Dimensions				Standard Pack Quantity
	Tube OD (mm)	Wall Thickness (mm)	Tube OD (ins)	Wall Thickness (gauge)	
SIG1245A	25.4 mm	1.7	1	16	2800
SIG1250A	25.4 mm	1.5	1	17	2800
SIG1255A	25.4 mm	1.2	1	18	2800
SIG1260A	25.4 mm	0.9	1	20	3200
SIG1265A	25.4 mm	0.9	1	22	3200
SIG1270A	28.6 mm	1.7	1.125	16	2200
SIG1275A	28.6 mm	1.2	1.125	18	2200
SIG1280A	31.8 mm	3	1.25	11	2000
SIG1285A	31.8 mm	2.8	1.25	12	2000
SIG1290A	31.8 mm	2.1	1.25	14	1500
SIG1295A	31.8 mm	1.7	1.25	16	1700
SIG1300A	31.8 mm	1.2	1.25	18	1800
SIG1305A	38.1 mm	3.4	1.5	10	1800
SIG1310A	38.1 mm	3	1.5	11	1200
SIG1315A	38.1 mm	2.8	1.5	12	1200
SIG1320C	38.1 mm	2.1	1.5	14	1300
SIG1325A	38.1 mm	1.7	1.5	16	1100
SIG1330A	38.1 mm	1.2	1.5	18	1200
SIG1335A	38.1 mm	0.9	1.5	20	1200
SIG1340A	44.5 mm	3	1.75	11	1000
SIG1345A	44.5 mm	2.1	1.75	14	1000
SIG1350A	44.5 mm	1.7	1.75	16	900
SIG1353C	50.8 mm	3	2	11	1000
SIG1365A	50.8 mm	2.8	2	12	1000
SIG1370A	50.8 mm	2.1	2	14	1000
SIG1375A	50.8 mm	1.7	2	16	1000
SIG1380A	50.8 mm	1.2	2	18	1000
SIG1385A	63.5 mm	3	2.5	11	500
SIG1390A	76.2 mm	3	3	11	500

*Clear butyrate material

TUBE INSERTS

Lightweight Square Inserts

SR 1542

Black Polyethylene

- Provide neat, finished appearance
- For wall thicknesses of 1.0 - 2.0mm

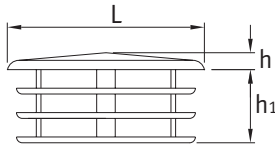

Part Number	Dimensions (mm)			Standard Pack Quantity
	L	h1	h	
465482	12	9	3	5000
460927	14	10	3	5000
465479	15	11	3	5000
460929	16	10	3	5000
460930	18	10	3	5000
465477	20	11	4	3000
465476	25	15	5	2500
465481	30	15	5	2000
460934	35	15	4	1500
465480	40	16	4	750

Angled Square Inserts

SR 1555

Black Polyethylene

- Easy assembly
- Durable and long lasting

- Perfect for tube ends or uneven surfaces and for tubes which meet surfaces at an angle

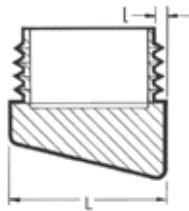
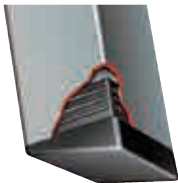

Angled Square Inserts (Imperial)

Part Number	Dimensions (mm)			Angle	Standard Pack Quantity
	L (ins)	l (mm)	l (mm)		
199276*	¾	19.1	1.2-1.6	5°	5000
199277*	¾	19.1	1.2-1.6	25°	2500

*With stacking buffers

Angled Square Inserts (Metric)

Part Number	Dimensions (mm)			Standard Pack Quantity
	L	l	Angle	
460767	18	1.0-2.0	10°	4000
466557	20	1.0-2.0	10°	500
199134*	20	1.2	25°	2500
199132	25	1.0-1.5	15°	1000

*With stacking buffers and light vertical ribbing

Chrome-Plated Square Inserts

SR 1543

Black Polyethylene

- Give neat, polished finish
- Ribbed for ease of fitting and positive fit
- For wall thicknesses of 1.0 - 2.0mm

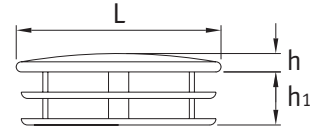

Part Number	Dimensions (mm)			Standard Pack Quantity
	L	h1	h	
465341	16	9	2	1000
460959	18	9	2	1000
465340	20	10	2	1000
465343	25	10	2	1000
465342	30	10	3	1000
460964	35	12	3	1000
465344	40	12	3	1000

Domed Square Inserts

SR 1556

Black Polyethylene

- Add attractive finish to high-quality tubular products



Part Number	Dimensions (mm)			Standard Pack Quantity
	L (ins)	L (mm)	l (mm)	
111525	-	20.0	0.8-2.0	2500
199163*	¾	22.2	0.9-1.6	1750
199260	1	25.4	0.9-1.6	1250

*Textured head finish.

Metal-Pronged Square Inserts

SR 1554

Steel

- Useful for fitting into tubular frames before finishing

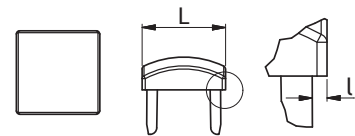

Part Number	Dimensions (mm)				Standard Pack Quantity
	L (mm)	L (ins)	l (gauge)	l (mm)	
PFGS222-16	22.2	¾	16	1.6	625
PFGS254-16	25.4	1	16	1.6	500

Chrome Square Inserts

SR 5722

ABS

- Provides a neat finish
- High Gloss Chrome finished inserts
- Available in Silver Chrome or Black Chrome



Part Number		Dimensions (mm)			Standard Pack Quantity
Silver Chrome	Black Chrome	L	l	h	
499145	499164	12 x 12	1.0	7.0	200
499146	499165	12 x 12	1.2	7.0	200
-	499166	15 x 15	1.0	8.0	200
499148	499167	15 x 15	1.2	8.0	200
499149	499168	15 x 15	1.5	8.0	200
499202	-	16 x 16	1.0	8.0	100
499203	-	16 x 16	1.5	8.0	100
499205	-	18 x 18	1.5	8.0	100
-	499169	20 x 20	1.0	8.0	200
499151	499170	20 x 20	1.2	8.0	200
-	499171	20 x 20	1.5	8.0	200
499153	-	25 x 25	1.0	8.0	200
499154	499173	25 x 25	1.2	8.0	200
-	499174	25 x 25	1.5	8.0	200
499156	499175	25 x 25	2.0	8.0	200
-	499176	30 x 30	1.0	10.0	100
-	499177	30 x 30	1.2	10.0	100
499159	499178	30 x 30	1.5	10.0	100
499207	-	35 x 35	1.5	11.0	100
499209	-	40 x 40	1.5	11.0	100
499210	-	45 x 45	1.2	11.0	100
499211	-	45 x 45	1.5	11.0	100
499160	499179	50 x 50	1.2	10.0	100
499161	499180	50 x 50	1.5	10.0	100
499162	-	50 x 50	2.0	10.0	100
499163	499182	50 x 50	3.0	10.0	100
499213	-	60 x 60	1.5	12.0	100
499214	-	80 x 80	1.2	12.0	100
499216	-	80 x 80	2.0	12.0	100

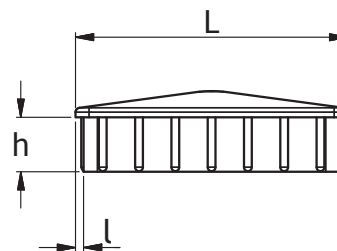

Large Square Tube Insert Glides

SR 1631

LDPE

- Ideal for general purpose tube-fitting applications
- Stepped lead for easy insertion and secure fit



Part Number	Dimensions				Standard Pack Quantity
	Tube OD (mm)	Wall Thickness (mm)	Tube OD (ins)	Wall Thickness (gauge)	
SQS5006A	127	4.9	5	6	50

TUBE INSERTS

Standard Round Ribbed Inserts – Black and White

SR 1530

LDPE

- Ribbed for easy assembly and secure fitting
- Cover sharp tube edges

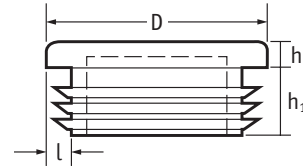

Part Number				Dimensions						Standard Pack Quantity
Black		White		D (mm)	D (ins)	h (mm)	h1 (mm)	l (mm)	l (gauge)	
Polished	Eroded	Polished	Eroded	10	–	3.5	11.5	0.8-2.0	–	2500
111489	111527	111565	111603	10	–	3.5	12	1.5-2.0	–	500
–	–	–	085010060303	10	–	3.5	12	1.5-2.0	–	500
111490	111528	111566	111604	12	–	3.5	11.5	0.8-2.0	–	2500
–	–	–	085012060303	12	–	3.5	12	1.5-2.0	–	500
111033	111053	111073	–	12.7	½	4	11.5	0.8-2.0	12-20	2500
111034	111054	111074	111094	13	–	4	11.5	0.8-2.0	–	2500
–	465609	–	–	14	–	5	11.5	1.5-2.0	–	2500
–	085014069903	–	085014060303	14	–	5	12	1.5-2.0	–	500
–	465610	–	–	15	–	5	11.5	0.8-2.0	–	2500
–	085015069903	–	085015060303	15	–	3	12	0.8-2.0	–	500
111035	111055	111075	111095	16	⅝	5	11.5	0.8-2.0	12-20	5000
–	–	–	085016060303	16	–	5	12	0.8-2.0	–	500
111491	111529	111567	111605	18	–	5	11.5	0.8-2.0	–	1500
111036	111056	111076	111096	19	¾	5	11.5	0.8-2.0	12-20	1500
111037	111057	111077	111097	20	–	5	11.5	0.8-2.0	–	1500
–	465608	–	–	21	–	5	11.5	0.8-2.0	–	1500
–	085021069903	–	085021060303	21	–	5	12	1.5-2.0	–	100
111038	111058	111078	111098	22	⅞	5	11.5	0.8-2.0	12-20	1500
–	–	–	085022060303	22	–	5	12	1.0-3.0	–	100
–	465598	–	–	23	–	5	11.5	0.8-2.5	–	1000
–	085023069903	–	085023060303	23	–	5	12	1.5-2.0	–	100
–	465599	–	–	24	–	5	11.5	1.0-2.5	–	1000
–	085024069903	–	085024060303	24	–	5	12	1.5-2.0	–	100
111039	111059	111079	111099	25	–	5	11.5	1.0-3.0	–	1000
111040	111060	111080	111100	25.4	1	5	11.5	1.0-3.0	10-18	1000
–	460665	–	–	26	–	5	11.5	1.0-3.0	–	1000
–	–	–	085026060303	26	–	5	12	1.5-2.0	–	100
–	085027069903	–	085027060303	27	–	5	12	1.0-3.0	–	100
111041	111061	111081	111101	28	–	5	11.5	1.0-3.0	–	1000
111042	111062	111082	111102	28.6	1⅜	5	11.5	1.0-3.0	10-18	1000
111043	111063	111083	111103	30	–	5	11.5	1.0-3.0	–	1000
–	–	–	085030060303	30	–	5	12	1.5-2.0	–	100
111044	111064	111084	–	32	1¼	5	11.5	1.0-3.0	10-18	1000
111045	111065	–	111105	34	–	5	11.5	1.0-3.0	–	1000
–	–	–	085034060303	34	–	5	12	1.0-3.0	–	50
111492	111530	–	111606	35	–	5	11.5	1.0-3.0	–	1500

CONTINUED ON NEXT PAGE

Standard Round Ribbed Inserts – Black and White CONTINUED

SR 1530

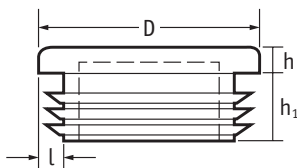

Part Number				Dimensions						Standard Pack Quantity
Black		White		D (mm)	D (ins)	h (mm)	h1 (mm)	l (mm)	l (gauge)	
Polished	Eroded	Polished	Eroded							
-	085036069903	-	085036060303	36	-	5	12	1.5-2.0	-	50
111493	111531	-	111607	37	-	5	11.5	1.0-3.0	-	1500
-	-	-	085037060303	37	-	5	12	1.5-2.0	-	50
111046	111066	111086	111106	38	1½	5	11.5	1.0-3.0	10-18	1000
-	-	-	085038060303	38	-	5	12	1.5-3.5	-	50
199278	-	-	-	38.1	1½	5	14.5	2.0-4.0	8-12	1500
111047	111067	-	111107	40	-	5	11.5	1.0-3.0	-	1000
111495	111533	111571	111609	41.3	1¾	5	11.5	1.0-3.0	11-20	1000
111494	111532	-	111608	42	-	5	11.5	1.0-3.0	-	1000
-	-	-	085042060303	42	-	5	12	0.8-2.5	-	50
-	085043069903	-	085043060303	43	-	5	12	2.0-2.5	-	50
111497	111535	-	111611	44.4	1¾	5	11.5	1.0-3.0	11-20	1000
111496	111534	-	111610	45	-	5	11.5	1.0-3.0	-	1000
-	-	-	085045060303	45	-	5	12	0.8-3.5	-	50
111498	111536	-	111612	47.6	1¾	5	11.5	1.0-3.0	11-20	800
111048	111068	-	111108	50	-	5	14.5	1.0-3.0	-	500
-	-	-	085050060303	50	-	5	12	1.0-3.0	-	50
111049	111069	111089	111109	50.8	2	5	14.5	1.0-3.0	10-18	500
-	465600	-	-	55	-	5	11.5	1.0-3.0	-	600
-	085055069903	-	085055060303	55	-	5	12	1.0-3.0	-	50
111050	111070	199832	111110	60	-	5	14.5	1.0-3.0	-	400
199209	-	-	-	60	-	6	20.1	3.5-5.0	-	400
-	-	-	085060060303	60	-	4	19	1.5-3.0	-	25
-	199268	-	-	63.5	2½	6	20	2.0-4.0	8-12	400
111500	111538	-	111614	63.5	2½	5	14.5	1.0-3.0	11-20	250
111499	111537	-	111613	65	-	5	14.5	1.0-3.0	-	250
-	-	-	085065060303	65	-	5	21	1.5-3.5	-	10
-	465601	-	085070060303	70	-	5	21	2.0-4.5	-	300
111051	111071	-	111111	75	-	6	22	2.0-4.0	-	250
-	-	-	085076160303	76.1	-	5	21	1.8-4.0	-	10
-	199271	111092	-	76.2	3	6.2	20.2	1.0-2.0	14-18	250
111052	111072	-	111112	76.2	3	6	22	2.0-4.0	8-14	250
-	465602	-	085080060303	80	-	4	21	1.5-3.0	-	360
-	465603	-	-	85	-	6	21	1.5-4.0	-	250
-	085088969903	-	085088960303	88.9	-	5	21	1.8-4.0	-	10
-	-	-	085090060303	90	-	6	21	2.5-5.0	-	10
-	465604	-	-	90	-	5	20	2.5-5.0	-	250
-	465605	-	-	95	-	6	21	1.5-4.0	-	125
-	465606	-	460687	100	-	6	28	2.0-4.5	-	80
-	465596	-	-	105	-	6	28	2.0-4.5	-	75
-	465597	-	085110060303	110	-	6	28	2.0-4.5	-	100
-	465607	-	085120060303	120	-	6	28	2.0-4.0	-	60
-	085140069903	-	085140060303	140	-	6	34	2.0-6.5	-	10
-	085150069903	-	085150060303	150	-	6	34	2.0-7.0	-	10
-	085160069903	-	-	160	-	5	34	5.0-7.0	-	10

Standard Round Ribbed Inserts – Mid and Dark Grey

SR 1530

- Mid Grey similar to RAL 7042
- Dark Grey similar to RAL 7011

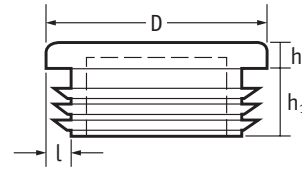

Part Number				Dimensions						Standard Pack Quantity
Mid Grey		Dark Grey		D (mm)	D (ins)	h (mm)	h1 (mm)	l (mm)	l (guage)	
Polished	Eroded	Polished	Eroded							
111641	111679	111717	111755	10	–	3.5	11.5	0.8-2.0	–	2500
–	085010062003	–	–	10	–	3.5	12	1.5-2.0	–	500
111642	111680	–	111756	12	–	3.5	11.5	0.8-2.0	–	2500
–	085012062003	–	–	12	–	3.5	12	1.5-2.0	–	500
111113	111114	111173	111153	12.7	½	4	11.5	0.8-2.0	12-20	2500
–	085013062003	–	–	13	–	4	12	0.8-2.0	–	500
–	085014062003	–	–	14	–	5	12	1.5-2.0	–	500
–	085015062003	–	–	15	–	3	12	0.8-2.0	–	500
111115*	111135	111155*	111175	16	⅝	5	11.5	0.8-2.0	12-20	5000
–	085016062003	–	–	16	–	5	12	0.8-2.0	–	500
111643	111681	111719	111757	18	–	5	11.5	0.8-2.0	–	1500
111116	111136	111156	111176	19	¾	5	11.5	0.8-2.0	12-20	1500
–	085019062003	–	–	19	–	5	12	0.8-2.0	–	100
111117	111137	111157	111177	20	–	5	11.5	0.8-2.0	–	1500
–	085020062003	–	–	20	–	5	12	0.8-2.5	–	100
–	085021062003	–	–	21	–	5	12	1.5-2.0	–	100
111118	111138	111158	111178	22	⅞	5	11.5	0.8-2.0	12-20	1000
–	085022062003	–	–	22	–	5	12	1.0-3.0	–	100
–	085023062003	–	–	23	–	5	12	1.5-2.0	–	100
–	085024062003	–	–	24	–	5	12	1.5-2.0	–	100
111119	111139	111159	111179	25	–	5	11.5	1.0-3.0	–	1000
–	085025062003	–	–	25	–	5	12	1.0-2.5	–	100
111120	111140	111160	111180	25.4	1	5	11.5	1.0-3.0	10-18	1000
–	085026062003	–	–	26	–	5	12	1.5-2.0	–	100
–	085027062003	–	–	27	–	5	12	1.0-3.0	–	100
111121	111141	111181	–	28	–	5	12.4	1.0-3.0	–	1000
–	085028062003	–	111182	28	–	5	12	1.0-2.5	10-18	100
111122	111142	111162	–	28.6	1⅜	5	11.5	1.0-3.0	–	1000
111123	111143	111163	–	30	–	5	11.5	1.0-3.0	–	1000
–	085030062003	–	111184	30	–	5	12	1.5-2.0	10-18	100
111124	111144	111164	–	32	1¼	5	11.5	1.0-3.0	–	1000
–	085032062003	–	–	32	–	5	12	0.8-2.5	–	100
–	085034062003	–	–	34	–	5	12	1.0-3.0	–	50
111644	111682	–	–	35	–	5	11.5	1.0-3.0	–	1500
–	085035062003	–	111758	35	–	5	12	1.0-2.5	–	50
–	085036062003	–	–	36	–	5	12	1.5-2.0	–	50
–	111683	–	111102	37	–	5	11.5	1.0-3.0	–	1500
–	085037062003	–	–	37	–	5	12	1.5-2.0	10-18	50
111126	111146	–	–	38	1½	5	11.5	1.0-3.0	–	1000
–	085038062003	–	–	38	–	5	12	1.5-3.5	8-12	50
110662	–	–	–	38.1	1½	5	14.5	2.0-4.0	–	1000

* Pack Qty = 2500

Standard Round Ribbed Inserts – Mid and Dark Grey CONTINUED

SR 1530

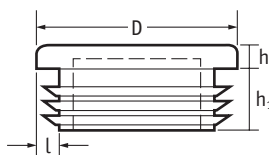

Part Number				Dimensions						Standard Pack Quantity
Mid Grey		Dark Grey		D (mm)	D (ins)	h (mm)	h1 (mm)	l (mm)	l (guage)	
Polished	Eroded	Polished	Eroded							
111127	111147	111167	111187	40	-	5	11.5	1.0-3.0	-	1000
-	111685	-	-	41.3	1½	5	11.5	1.0-3.0	11-20	1000
111646	111684	111722	111760	42	-	5	11.5	1.0-3.0	-	1000
-	085042062003	-	-	42	-	5	12	0.8-2.5	-	50
-	085043062003	-	-	43	-	5	12	2.0-2.5	-	50
-	111687	111725	111763	44.4	1¾	5	11.5	1.0-3.0	11-20	1000
111648	111686	-	111762	45	-	5	11.5	1.0-3.0	-	1000
-	085045062003	-	-	45	-	5	12	0.8-3.5	-	50
111650	111688	-	111764	47.6	1¾	5	11.5	1.0-3.0	11-20	800
-	085049062003	-	-	48	-	5	12	1.2-3.6	-	50
111128	111148	111168	111188	50	-	5	14.5	1.0-3.0	-	500
-	085050062003	-	-	50	-	5	12	1.0-3.0	-	50
-	085055062003	-	-	55	-	5	12	1.0-3.0	-	50
111130	-	-	-	60	-	5	14.5	1.0-3.0	-	400
-	111690	-	111766	63.5	2½	5	14.5	1.0-3.0	11-20	250
-	085065062003	-	-	65	-	5	21	1.5-3.5	-	10
-	085076162003	-	-	76.1	-	5	21	1.8-4.0	-	10
111131	111152	111172	111192	76.2	3	6	22	2.0-4.0	8-14	250
-	085080062003	-	-	80	-	4	21	1.5-3.0	-	10
-	085088962003	-	-	88.9	-	5	21	1.8-4.0	-	10
-	085090062003	-	-	90	-	6	21	2.5-5.0	-	10
-	085100062003	-	-	100	-	6	28	2.0-4.5	-	10
-	085110062003	-	-	110	-	6	28	2.0-4.5	-	10
-	085120062003	-	-	120	-	6	28	2.0-4.0	-	10
-	085140062003	-	-	140	-	6	34	2.0-6.5	-	10
-	085150062003	-	-	150	-	6	34	2.0-7.0	-	10
-	085160062003	-	-	160	-	5	34	5.0-7.0	-	10
-	085168362003	-	-	168.3	-	5	34	2.0-6.5	-	10

Standard Round Ribbed Inserts – Coloured

SR 1530

LDPE - Various Colours

- Eroded head
- Ideal for educational or play equipment



Part Number					Dimensions			Standard Pack Quantity
Yellow	Red	Green	Blue	Brown	D (mm)	D (ins)	l (mm)	
111818	111820	111821	111822	111823	16.0	¾	0.8-2.0	2500
111883	111884	111885	111886	111887	18.0	-	0.8-2.0	1500
111906	805197	111907	111908	111825	19.0	¾	0.8-2.0	1500
111889	111890	111891	111892	111893	20.0	-	0.8-2.0	1500
111870	111827	111828	111909	111911	22.0	7/8	0.8-2.0	1500
111895	111896	111897	111898	111899	25.0	-	1.0-3.0	1000
111830	111831	111832	111833	111834	25.4	1	1.0-3.0	1000
199717	199718	111836	111910	111837	32.0	1¼	1.0-3.0	1000

TUBE INSERTS

Heavy-Duty Round Inserts

SR 1565

LDPE

- Ideal as heavy-duty feet for tubular products

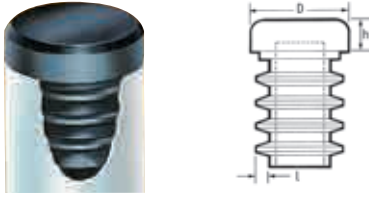

Black Inserts

Part Number	Dimensions				Standard Pack Quantity
	D (ins)	D (mm)	l (mm)	h (mm)	
199099	3/4	19.5	1.2 - 2.0	6.4	5000
199100	7/8	22.2	1.2 - 2.0	6.4	2500
199085	1	25.4	1.2 - 2.0	7.9	500
199087	1 1/8	28.5	1.2 - 2.0	7.9	1500
199089	1 1/4	31.7	1.2 - 2.0	15.9	500

Coloured Inserts

Part Number	Colour	Dimensions			Standard Pack Quantity
		D (mm)	l (mm)	h (mm)	
464526	Yellow	19.5	1.2 - 2.0	6.4	5000
464527	White	19.5	1.2 - 2.0	6.4	5000
468550	Yellow	22.2	1.2 - 2.0	6.4	2500
468551	White	22.2	1.2 - 2.0	6.4	2500
464524	Green	22.2	1.2 - 2.0	6.4	2500
464616	Blue	22.2	1.2 - 2.0	6.4	2500

Lightweight Round Inserts

SR 1560

Black Polyethylene

- Easy assembly
- Offer a high-quality finish to a variety of tubular products
- Imperial range with plain shank
- Metric range with ribbed shank

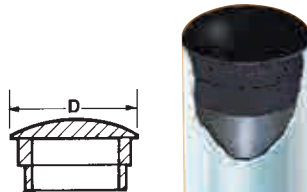

Plain Shank (Imperial)

Part Number			Head Size		Standard Pack Quantity
Gauge 16	Gauge 18	Gauge 20	D		
			(ins)	(mm)	
199091	199093	-	1/2	12.7	10000
199004	199006	199008	5/8	15.8	10000
199076	199078	199080	3/4	19.0	5000
199232*	199232*	199232*	3/4	19.0	5000
10755	199052	-	7/8	22.2	7000
199069	199070	-	1	25.4	5000
199072	199073	-	1 1/8	28.6	4000
199067	199068	-	1 1/4	31.7	2500
199119	199120	-	1 3/8	34.9	2500
-	199084	-	1 1/2	38.1	2000
-	11316	-	2	50.8	800

*Ribbed short shank.

Chrome-Plated Round Inserts

SR 1562

Black Polyethylene

- Attractive chrome-plated finish provides enhanced aesthetic appearance
- Ribbed for ease of insertion and positive fit



Part Number	Dimensions				Standard Pack Quantity
	Wall Thickness	D	h	h1	
465335	1.5	13.0	8.0	2.0	4000
463586	1.5	16.0	10.0	2.0	2000
465333	1.5	18.0	10.0	2.0	2000
465336	1.5	19.0	10.0	2.0	3000
465338	1.5	20.0	10.0	3.0	2000
465334	1.5	22.0	11.0	3.0	2000
462994	1.5	25.0	15.0	3.0	2000
463587	1.5	28.0	15.0	3.0	2000
463020	1.5	30.0	16.0	3.0	2000
463588	1.5	32.0	16.0	3.0	2000
463021	1.5	35.0	16.0	3.0	2000
465337	1.5	38.0	16.0	3.0	1000
463022	1.5	40.0	16.0	3.0	1000
465339	1.5	45.0	16.0	3.0	750
463023	1.5	50.0	12.0	3.0	200
465332	1.5	60.0	12.0	3.0	200

Ribbed (Metric)

Part Number	Dimensions (mm)				Standard Pack Quantity
	D	Wall Thickness	Shank Height	Head Height	
1318184	10	0.8-1.5	11.5	2	5000
1298772	12	1.5-2.0	11.5	2	5000
1298773	14	1.5-2.0	11.5	3	5000
1298774	15	0.8-2.0	11.5	3	2500
1298775	16	0.8-2.0	11.5	3	2500
1318185	18	0.8-2.0	11.5	3	2000
1318186	19	0.8-2.0	11.5	3	2000
1298776	20	0.8-2.5	11.5	3	2000
1298777	22	1.0-2.5	11.5	3	2000
1318187	24	1.0-2.5	11.5	3	2000
1298778	25	1.0-2.5	11.5	3	3500
1339575	28	0.8-2.5	11.5	3	3000
1339577	30	0.8-2.5	11.5	3	2500
1339578	32	0.8-2.5	11.5	3	2250
1351002	35	1.0-3.0	11.5	3	1750
1351003	38	1.0-3.0	11.5	3	1500
1339576	40	1.0-3.0	11.5	3	1500
460789	42	0.8-2.5	11.5	3	1250
1350661	45	1.0-3.0	11.5	3	1000
466580	50	1.0-2.5	11.5	3	800
466581	55	1.0-3.0	14.5	3	700
466582	60	1.5-3.0	18.0	3	500

Round Load Bearing Glides

SR 1632

Black ABS unless otherwise stated

- Designed for use as a glide or plug style closure
- Stepped lead for easy insertion and secure fit
- Ideal for moderate to heavy-duty applications



Part Number	Dimensions				Standard Pack Quantity
	Tube OD (mm)	Wall Thickness (mm)	Tube OD (ins)	Wall Thickness (gauge)	
RDG1100A	9.5	1.1	0.375	19	9000
RDG1105A	12.7	1.7	0.5	16	10000
RDG1110A	12.7	1.2	0.5	18	15000
RDG1115A	12.7	0.9	0.5	20	15000
RDG1120A	12.7	0.8	0.5	21	15000
RDG1125A	12.7	0.7	0.5	22	13000
RDG1127A1	14.3	1.1	0.563	19	10000
RDG1130A	14.3	0.9	0.563	20	13000
RDG1135A	14.3	0.7	0.563	22	6500
RDG1140A	15.9	3	0.625	11	13000
RDG1145A	15.9	2.8	0.625	12	13000
RDG1150A	15.9	2.4	0.625	13	15000
RDG1155D	15.9	2.1	0.625	14	3000
RDG1160A	15.9	1.8	0.625	15	7000
RDG1165A	15.9	1.7	0.625	16	7000
RDG1168B2	15.9	1.5	0.625	17	10000
RDG1170A	15.9	1.5	0.625	17	8000
RDG1175A	15.9	1.2	0.625	18	8000
RDG1180A	15.9	0.9	0.625	20	5000
RDG1185A	15.9	0.7	0.625	22	8000
RDG1190A	19.1	2.4	0.75	13	6500
RDG1195C	19.1	2.1	0.75	14	1500
RDG1196A	19.1	2.1	0.75	14	6500
RDG1200A	19.1	1.7	0.75	16	7000
RDG1205A	19.1	1.5	0.75	17	8000
RDG1210A	19.1	1.2	0.75	18	7000
RDG1215A	19.1	1.1	0.75	19	6500
RDG1220A	19.1	0.9	0.75	20	6500
RDG1225A	19.1	0.7	0.75	22	3000
RDG1228B3	22.2	2.4	0.875	13	4500
RDG1230A	22.2	2.1	0.875	14	5000
RDG1235A	22.2	1.7	0.875	16	5000
RDG1237B4	22.2	1.5	0.875	17	5000
RDG1240A	22.2	1.2	0.875	18	4500
RDG1245A	22.2	1.1	0.875	19	5000
RDG1250A	22.2	0.9	0.875	20	4500
RDG1255A	25.4	2.8	1	12	4000
RDG1264B2	25.4	2.1	1	14	4000
RDG1265A	25.4	2.1	1	14	4000
RDG1270A	25.4	1.8	1	15	4000
RDG1273B2	25.4	1.7	1	16	4000
RDG1274D4	25.4	1.7	1	16	3500

Part Number	Dimensions				Standard Pack Quantity
	Tube OD (mm)	Wall Thickness (mm)	Tube OD (ins)	Wall Thickness (gauge)	
RDG1275A	25.4	1.7	1	16	4000
RDG1280A	25.4	1.5	1	17	3500
RDG1285A	25.4	1.2	1	18	3500
RDG1290A	25.4	1.1	1	19	3500
RDG1295C	25.4	0.9	1	20	3500
RDG1305C	28.6	2.8	1.125	12	2500
RDG1310A	28.6	2.1	1.125	14	2800
RDG1315A	28.6	1.7	1.125	16	2800
RDG1320B	28.6	1.2	1.125	18	2800
RDG1325A	28.6	1.1	1.125	19	2800
RDG1327B3	28.7	0.9	1.13	20	2400
RDG1330A	31.8	3	1.25	11	2500
RDG1335C	31.8	2.8	1.25	12	2500
RDG1340A	31.8	2.1	1.25	14	2300
RDG1345A	31.8	1.7	1.25	16	2300
RDG1350D	31.8	1.2	1.25	18	2300
RDG1355A	34.9	2.4	1.375	13	1100
RDG1360A	34.9	2.1	1.375	14	2000
RDG1365A	34.9	1.7	1.375	16	2000
RDG1370C	34.9	1.2	1.375	18	2000
RDG1375A	34.9	0.9	1.375	20	1600
RDG1380A	38.1	2.8	1.5	12	1200
RDG1385A	38.1	2.1	1.5	14	1500
RDG1390A	38.1	1.7	1.5	16	1500
RDG1394B2	38.1	1.2	1.5	18	1400
RDG1395D	38.1	1.2	1.5	18	1500
RDG1400A	38.1	1.1	1.5	19	1500
RDG1405A	38.1	0.9	1.5	20	1500
RDG1408B4	41.3	1.7	1.625	16	1400
RDG1410A	41.3	1.2	1.625	18	1000
RDG1415A	44.5	3	1.75	11	1100
RDG1420A	44.5	2.1	1.75	14	1100
RDG1425A	44.5	1.7	1.75	16	1100
RDG1430A	44.5	1.2	1.75	18	1100
RDG1435A	44.5	0.9	1.75	20	1000
RDG1445A	50.8	3	2	11	850
RDG1455A	50.8	1.7	2	16	850
RDG1460A	50.8	1.2	2	18	850
RDG1465A	50.8	0.9	2	20	1000
RDG1470A	63.5	1.2	2.5	18	500
RDG1475A	76.2	1.7	3	13	500
RDG1274D	25.4	1.7	1	16	3500

1 - HDPE 2 - Butyrate 3 - LDPE 4 - Polyamide

EVEN MORE CHOICE ONLINE

OVER 30,000 PRODUCTS

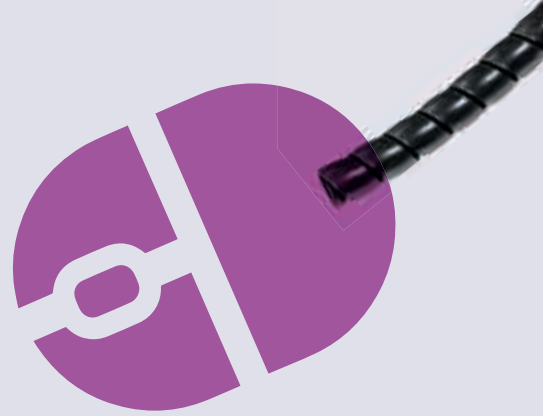

KD
FITTINGS



DAMPERS



DESK CABLE
TIDIES



TOGGLE
CLAMPS



CARD GUIDE
AND PULLERS



SCAFFOLDING



LED
HARDWARE

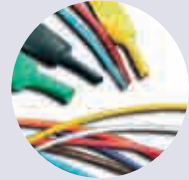

HEAT
SHRINK



SIGN & PRINT
FIXTURES



IGUS



SECURITY
SEALS



FERRITES



JUNCTION AND
ENCLOSURE BOXES
& SPRINGS



TAPES



FULL FLANGE
GASKETS

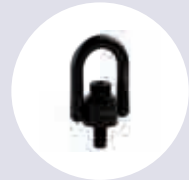

LIFTING
COMPONENTS



TEL: 0845 758 5070

www.essentracomponents.co.uk

Chrome Round Inserts

SR 5723

ABS

- Provides a neat finish
- High gloss chrome finished inserts
- Available in silver or black chrome finishes

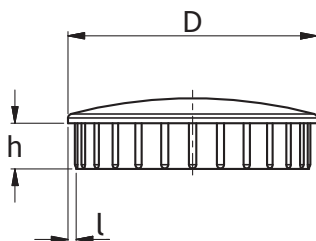

Part Number		Dimensions (mm)			Standard Pack Quantity
Silver Chrome	Black Chrome	D	l	h	
499051	499089	8.0	1.0	4.5	200
499052	499090	10.0	1.0	5.0	200
499053	499091	12.0	1.0	5.0	200
499054	499092	13.0	1.0	5.0	200
499055	499093	14.0	1.0	5.0	200
499183	-	16.0	1.0	8.0	100
499184	-	16.0	1.2	8.0	100
499185	-	16.0	1.5	8.0	100
499056	-	18.0	1.0	8.0	200
499057	499095	18.0	1.2	8.0	200
499058	499096	18.0	1.5	8.0	200
499059	-	20.0	1.0	5.0	200
-	499098	20.0	1.2	5.0	200
499061	499099	20.0	1.5	5.0	200
499062	-	22.0	1.0	8.0	200
-	499101	22.0	1.2	8.0	200
-	499102	22.0	1.5	8.0	200
-	499103	22.0	2.0	8.0	200
499066	499104	25.0	1.0	8.0	200
499067	499105	25.0	1.2	8.0	200
499068	499106	25.0	1.5	8.0	200
499069	499107	25.0	2.0	8.0	200
499070	-	25.0	2.5	8.0	200
499188	-	28.0	1.0	10.0	100
499189	-	28.0	1.2	10.0	100
499190	-	28.0	1.5	10.0	100
499072	499110	30.0	1.2	10.0	200
499073	499111	30.0	1.5	10.0	200
499074	499112	30.0	2.0	10.0	200
499075	499113	32.0	1.2	10.0	200
499076	499114	32.0	1.5	10.0	200
499077	499115	32.0	2.0	10.0	200
499078	499116	32.0	3.0	10.0	200

Part Number		Dimensions (mm)			Standard Pack Quantity
Silver Chrome	Black Chrome	D	l	h	
-	499117	35.0	1.0	10.0	200
499080	499118	35.0	1.2	10.0	200
499081	499119	35.0	1.5	10.0	200
499082	499120	35.0	2.0	10.0	200
499192	-	38.0	1.5	10.0	100
499193	-	38.0	2.0	10.0	100
499083	499121	40.0	1.0	10.0	200
499084	499122	40.0	1.5	10.0	100
499085	499123	40.0	2.0	10.0	100
499195	-	50.0	1.0	11.0	100
499196	-	50.0	1.2	11.0	100
499197	-	50.0	1.5	11.0	100
499198	-	50.0	2.0	11.0	100
499086	499124	60.0	1.0	11.0	100
-	499125	60.0	1.2	11.0	100
499088	499126	60.0	1.5	11.0	100

TUBE INSERTS

Angled Round Inserts

SR 1555

Black Polyethylene

- Easy assembly
- Durable and long lasting
- Perfect for tube ends on uneven surfaces and for tubes which meet surfaces at an angle

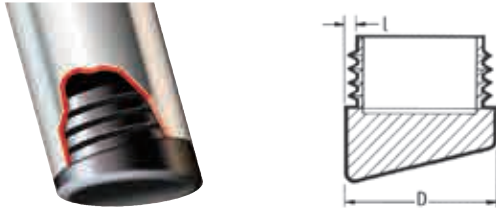

Imperial

Part Number	Dimensions (mm)			Angle	Standard Pack Quantity
	D		l (mm)		
	(ins)	(mm)			
199032	¾	19.1	1.6	15°	2000
110356*	¾	19.1	1.6	15°	4000

*With alignment grooves.

Metric

Part Number	Dimensions (mm)		Angle	Standard Pack Quantity
	D	l (mm)		
460751	18	1.5-2.0	15°	1000
497419	20	1.5-2.0	15°	1000
497420	22	1.5-2.0	15°	1000
497421	25	1.5-2.0	15°	1000

Metal-Pronged Round Inserts

SR 1554

Steel

- Useful for fitting into tubular frames before finishing

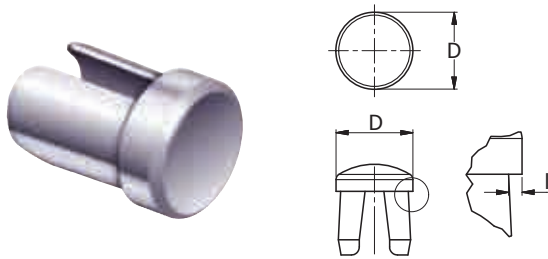

Part Number	Dimensions (mm)				Standard Pack Quantity
	D (ins)	D (mm)	l (gauge)	l (mm)	
PFGR190-16	¾	19.1	16	1.6	850
PFGR254-16	1	25.4	16	1.6	500
PFGR254-18	1	25.4	18	1.2	500
PFGR317-16	1¼	31.7	16	1.6	250

Domed Round Inserts

SR 1555

Black Polyethylene

- Add attractive finish to high-quality tubular products

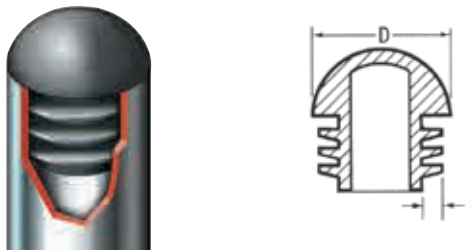

Imperial (Polished Finish)

Part Number	Dimensions (mm)				Standard Pack Quantity
	D		l (gauge)	l (mm)	
	(ins)	(mm)			
111522	¾	22.2	14.0-20.0	1.0-2.0	4000
199275	1¼	31.7	16.0-20.0	1.5-2.0	2000

Metric (Textured Finish)

Part Number	Dimensions (mm)		Standard Pack Quantity
	D	l	
465325	16	1.5-2.0	4000
465324	18	1.5-2.0	4000
111559	20	0.8-2.0	2500
111560	22	0.8-2.0	2000
111561	25	0.8-2.0	2000
465321	28	1.5-2.0	1500
465323	30	1.5-2.0	1000
465322	32	1.5-2.0	1500
111562	35	0.8-2.0	1500
465318	40	1.5-2.0	500

Ribbed Rectangular Inserts

SR 1550

LDPE

- Ideal for most popular sizes and gauges of rectangular tubes

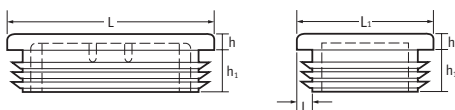

Part Number				Dimensions						Standard Pack Quantity
Black		White		L x L1 (mm)	L x L1 (ins)	h (mm)	h1 (mm)	l (mm)	l (gauge)	
Polished	Eroded	Polished	Eroded							
111337	111354	-	-	20 x 10	-	3	11.5	0.8 - 2.0	-	2000
-	057201069903	-	057201060303	20 x 10	-	3	11.5	1.0-2.0	-	100
-	057201269903	-	057201260303	20 x 12	-	2	9.5	1.0-1.5	-	100
-	498698	-	-	20 x 15	-	3	11.5	1.0 - 2.0	-	2000
-	057201569903	-	057201560303	20 x 15	-	5	11.5	1.0-1.5	-	100
-	057201669903	-	-	20 x 16	-	5	11.5	1.5-2.0	-	100
111338	111355	-	-	25 x 10	-	3	11.5	0.8 - 2.0	-	2000
-	057251069903	-	057251060303	25 x 10	-	4	11.5	1.5-2.0	-	100
-	462363	-	-	25 x 12	-	3	11.5	1.0 - 2.0	-	1000
-	498699	-	-	25 x 15	-	5	11.5	0.8 - 2.5	-	1000
-	057251569903	-	057251560303	25 x 15	-	5	11.5	1.0-2.5	-	100
-	498700	-	-	25 x 20	-	5	11.5	1.0 - 3.0	-	1000
-	057252069903	-	057252060303	25 x 20	-	5	11.5	1.5-2.0	-	100
111339	111356	-	-	25.4 x 12.7	1 x ½	3	11.5	0.8 - 2.0	14-20	2000
-	498701	-	-	30 x 10	-	3	11.5	0.75 - 2.0	-	1000
199254	-	-	-	30 x 10	-	5	12	1.0 - 1.5	-	5000
-	057301069903	-	057301060303	30 x 10	-	4	11.5	1.5-2.0	-	100
111340	111357	111374	111391	30 x 15	-	5	11.5	1.0 - 3.0	-	1000
-	057301569903	-	057301560303	30 x 15	-	5	12	1.0-2.0	-	100
111341	111358	-	-	30 x 20	-	5	11.5	1.0 - 3.0	-	1000
-	057302069903	-	057302060303	30 x 20	-	6	12	1.0-2.0	-	100
-	498702	-	-	30 x 25	-	5	13.5	1.5 - 2.0	-	1000
-	057302569903	-	057302560303	30 x 25	-	5	13.5	1.5-1.5	-	100
111508	111546	-	111622	34.9 x 15.9	1¾ x ¾	4	11.5	1.0 - 3.0	11-20	2500
-	498703	-	-	35 x 15	-	3.5	11.5	1.0 - 3.0	-	1000
-	057351569903	-	057351560303	35 x 15	-	5	11.5	1.0-3.0	-	100
111509	111547	-	111623	35 x 20	-	5	11.5	1.0 - 3.0	-	2000
-	057352069903	-	057352060303	35 x 20	-	5	11.5	1.5-2.5	-	100
-	057352569903	-	057352560303	35 x 25	-	5	11.5	1.5-2.0	-	100
111343	111360	111377	-	38.1 x 19.1	1½ x ¾	5	11.5	1.0 - 3.0	10-18	1000
199203	-	-	-	38.1 x 19.1	1½ x ¾	5	11.5	1.0 - 2.0	14-18	2500
111510	111548	-	111624	38.1 x 25.4	1½ x 1	5	11.5	1.0 - 3.0	11-20	2000
-	057401069903	-	-	40 x 10	-	5	11	1.0-3.0	-	100
-	498704	-	-	40 x 15	-	5	11.7	1.5 - 2.0	-	1000
-	057401569903	-	057401560303	40 x 15	-	5	11.7	1.0-3.0	-	100
111344	111361	111378	-	40 x 20	-	5	11.5	1.0 - 3.0	-	1000
-	057402069903	-	057402060303	40 x 20	-	6	14.5	1.5-2.0	-	100
111511	111549	-	111625	40 x 25	-	5	11.5	1.0 - 3.0	-	1500
10175	497831	-	-	40 x 27	-	5	11.5	1.2 - 1.7	-	1500
111345	111362	-	-	40 x 30	-	5	11.5	1.0 - 3.0	-	1000
-	498705	-	-	45 x 15	-	5	11	1.5 - 2.0	-	1000

CONTINUED ON NEXT PAGE

Ribbed Rectangular Inserts CONTINUED

SR 1550

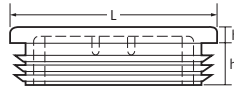

Part Number				Dimensions					Standard Pack Quantity	
Black		White		L x L1 (mm)	L x L1 (palec)	h (mm)	h1 (mm)	l (mm)		l (gauge)
Polished	Eroded	Polished	Eroded							
-	460722	-	-	45 x 20	-	5	11.5	1.0 - 3.0	-	2000
-	057452069903	-	057452060303	45 x 20	-	5	11.5	1.5 - 2.0	-	100
-	460723	-	-	45 x 25	-	5	11.5	1.0 - 3.0	-	1250
-	057452569903	-	057452560303	45 x 25	-	5	11.5	1.5 - 2.0	-	50
-	460724	-	-	45 x 30	-	5	11.5	1.0 - 2.5	-	1250
-	057501069903	-	057501060303	50 x 10	-	3.5	11.5	0.8 - 2.0	-	50
111346	111363	-	-	50 x 20	-	5	11.5	1.0 - 3.0	-	1000
-	057502069903	-	057502060303	50 x 20	-	5	14.5	1.0 - 3.0	-	50
111347	111364	111381	-	50 x 25	-	5	11.5	1.0 - 3.0	-	1000
-	057502569903	-	057502560303	50 x 25	-	5	14.5	1.0 - 3.0	-	50
111349	111366	111383	-	50 x 30	-	5	11.5	1.0 - 3.0	-	1000
-	057503069903	-	057503060303	50 x 30	-	5	14.5	1.0 - 3.0	-	50
111512	111550	-	111626	50.8 x 31.8	2 x 1 ¼	5	11.5	1.0 - 3.0	11-20	1000
-	057503469903	-	057503460303	50 x 34	-	5	14.5	1.0 - 3.5	-	50
-	498706	-	-	50 x 40	-	5	12	1.5 - 2.0	-	1000
-	057504069903	-	057504060303	50 x 40	-	5	12	1.0 - 3.0	-	50
111348	111365	111382	-	50.8 x 25.4	2 x 1	5	11.5	1.0 - 3.0	10-18	1000
-	057553469903	-	057553460303	55 x 34	-	5	14.5	1.5 - 4.0	-	25
111513	111551	-	111627	60 x 20	-	5	14.5	1.0 - 3.0	-	1000
-	057602069903	-	057602060303	60 x 20	-	5	14.5	1.5 - 2.0	-	25
18418	18422	-	-	60 x 25	-	5	11.5	3.0 - 4.5	-	1000
-	057602569903	-	057602560303	60 x 25	-	5	14.5	1.0 - 2.5	-	25
111481	111482	-	-	60 x 30	-	5	14.5	1.0 - 3.0	-	500
111350	111367	111384	111401	60 x 30	-	5	14.5	2.0 - 4.0	-	500
-	057603069903	-	057603060303	60 x 30	-	5	14.5	1.0 - 2.5	-	25
111802	111803	-	057604060303	60 x 40	-	5	14.5	1.0 - 3.0	-	500
111351	111368	-	-	60 x 40	-	5	14.5	2.0 - 4.0	-	500
-	057605069903	-	057605060303	60 x 50	-	5	14.5	1.5 - 3.5	-	25
10913	-	-	-	63.5 x 25.4	2½ x 1	5	11.5	1.0 - 2.0	16-18	1000
199184	-	-	-	63.5 x 25.4	2½ x 1	5.5	11.5	1.0 - 2.0	16-18	1000
199238	-	-	-	63.5 x 38.1	2½ x 1½	6.2	18	2.0 - 2.5	12-16	500
460726	057702069903	-	-	70 x 20	-	5	18.8	1.0 - 2.0	-	500
-	498707	-	-	70 x 25	-	5	17	1.0 - 2.0	-	500
-	057703069903	-	-	70 x 30	-	5.7	17.7	1.0 - 2.0	-	25
-	057704069903	-	057704060303	70 x 40	-	5	17.1	1.0 - 2.0	-	10
-	057705069903	-	-	70 x 50	-	5	14.5	2.0 - 5.0	-	10
-	199283	-	-	75 x 25	-	5	13	1.5 - 2.0	-	500
111514	111552	-	111628	76.2 x 38.1	3 x 1½	6	14.5	2.0 - 4.0	8-14	250
111515	111553	-	111629	75 x 50	-	6	22	2.0 - 4.0	-	250
111516	111554	-	-	76.2 x 50.8	3 x 2	6	22	2.0 - 4.0	8-14	250
-	498708	-	-	70 x 30	-	5.7	17.7	1.0 - 2.0	-	500
-	498709	-	-	70 x 40	-	5	17.1	1.0 - 2.0	-	500
-	498710	-	-	70 x 50	-	5	14.5	1.0 - 2.0	-	350
-	498711	-	057802060303	80 x 20	-	6	17.6	1.0 - 2.0	-	600
-	498712	-	-	80 x 25	-	5	14.5	1.0 - 2.0	-	550
-	498713	-	057803060303	80 x 30	-	5	14.5	1.0 - 2.5	-	500

Ribbed Rectangular Inserts *CONTINUED*

SR 1550

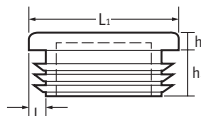

Part Number				Dimensions					Standard Pack Quantity	
Black		White		L x L1 (mm)	L x L1 (palec)	h (mm)	h1 (mm)	l (mm)		l (gauge)
Polished	Eroded	Polished	Eroded							
111473	057804069903	-	057804060303	80 x 40	-	5	14.5	1.0 - 3.0	-	250
111352	111369	-	111403	80 x 40	-	5	14.5	2.0 - 4.0	-	250
111353	111370	-	-	80 x 50	-	5	22	2.0 - 4.0	-	250
-	057805069903	-	-	80 x 50	-	5	24.5	2.0 - 4.0	-	10
-	498714	-	057806060303	80 x 60	-	5	24	1.5 - 3.5	-	150
-	460735	-	-	90 x 20	-	5	14.5	1.5 - 2.0	-	600
-	460736	-	-	90 x 40	-	5	14.5	2.0 - 4.0	-	300
-	498715	-	057807060303	90 x 50	-	6	21.5	2.0 - 4.5	-	200
-	057808069903	-	-	90 x 70	-	6	21.5	3.0 - 5.5	-	10
-	498691	-	-	100 x 20	-	5	14.5	1.5 - 3.0	-	500
-	498692	-	-	100 x 25	-	5	14.5	1.5 - 3.0	-	450
-	460740	-	057809060303	100 x 30	-	5	14.5	1.5 - 3.5	-	350
-	199231	-	199712	100 x 40	-	7.2	19	2.0 - 4.0	-	250
-	057810069903	-	057810060303	100 x 40	-	5	14.5	1.5 - 4.0	-	25
-	199195	-	-	100 x 50	-	8	18.5	2.0 - 4.0	-	200
-	057811069903	-	-	100 x 50	-	5	24	2.0 - 3.0	-	10
-	498693	-	057812060303	100 x 60	-	6	24.5	2.5 - 4.5	-	125
-	498694	-	057813060303	100 x 80	-	6	24	3.0 - 5.5	-	100
-	057814069903	-	-	110 x 60	-	6	24	3.5 - 5.5	-	10
-	057815069903	-	-	110 x 70	-	6	24	3.0 - 5.0	-	10
-	460743	-	057903060303	120 x 30	-	5	14.5	1.5 - 2.0	-	300
-	498696	-	057904060303	120 x 40	-	6	21.5	3.0 - 5.0	-	200
-	498689	-	-	120 x 50	-	6	21.5	3.0 - 5.5	-	150
111517	111555	111593	111631	120 x 60	-	6	22	2.0 - 4.0	-	100
-	057906069903	-	057906060303	120 x 60	-	5	24.5	2.0 - 4.0	-	10
498697	-	-	057908060303	120 x 80	-	5	24.5	2.0 - 3.0	-	75
-	498695	-	057910060303	120 x 100	-	6	24	3.5 - 6.0	-	60
-	057912069903	-	057912060303	140 x 80	-	5	24.5	2.0 - 4.5	-	10
-	460749	-	057913060303	150 x 50	-	6	28	2.0 - 4.0	-	100
-	498690	-	057914060303	150 x 100	-	7	27.5	3.0 - 8.0	-	100

Ribbed Rectangular Inserts

SR 1550

- Mid Grey similar to RAL 7042
- Dark Grey similar to RAL 7011

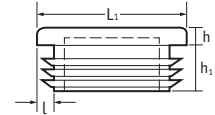
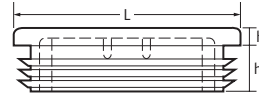

Part Number				Dimensions					Standard Pack Quantity	
Mid Grey		Dark Grey		L x L1 (mm)	L x L1 (ins)	h (mm)	h1 (mm)	l (mm)		l (gauge)
Polished	Eroded	Polished	Eroded							
-	057201062003	-	-	20 x 10	-	3	11.5	1.0 - 2.0	-	100
-	057201262003	-	-	20 x 12	-	2	9.5	1.0 - 1.5	-	100
-	057201562003	-	-	20 x 15	-	5	11.5	1.0 - 1.5	-	100
-	057201662003	-	-	20 x 16	-	5	11.5	1.5 - 2.0	-	100
111406	111423	-	-	25 x 10	-	3	11.5	0.8 - 2.0	-	2000
-	057251062003	-	-	25 x 10	-	4	11.5	1.5 - 2.0	-	100
-	057251562003	-	-	25 x 15	-	5	11.5	1.0 - 2.5	-	100
-	057252062003	-	-	25 x 20	-	5	11.5	1.5 - 2.0	-	100
-	057301062003	-	-	30 x 10	-	4	11.5	1.5 - 2.0	-	100
111408	-	111442	-	30 x 15	-	5	11.5	1.0 - 3.0	-	1000
-	057301562003	-	-	30 x 15	-	5	12	1.0 - 2.0	-	100
-	-	111443	-	30 x 20	-	5	11.5	1.0 - 3.0	-	1000
-	057302062003	-	-	30 x 20	-	6	12	1.0 - 2.0	-	100
-	-	-	-	30 x 25	-	5	13.5	1.5 - 1.5	-	100
-	111698	-	111774	34.9 x 15.9	1 3/8 x 5/8	4	11.5	1.0 - 3.0	11-20	2500
-	057351562003	-	-	35 x 15	-	5	11.5	1.0 - 3.0	-	100
-	111699	-	111775	35 x 20	-	5	11.5	1.0 - 3.0	-	2000
-	057352062003	-	-	35 x 20	-	5	11.5	1.5 - 2.5	-	100
-	057352562003	-	-	35 x 25	-	5	11.5	1.5 - 2.0	-	100
-	111428	-	-	38.1 x 19.1	1 1/2 x 3/4	5	11.5	1.0 - 3.0	10-18	1000
-	111700	-	-	38.1 x 25.4	1 1/2 x 1	5	11.5	1.0 - 3.0	11-20	2000
-	-	-	-	40 x 10	-	5	11	1.0 - 3.0	-	100
-	057401562003	-	-	40 x 15	-	5	11.7	1.0 - 3.0	-	100
-	111429	-	111463	40 x 20	-	5	11.5	1.0 - 3.0	-	1000
-	057402062003	-	-	40 x 20	-	6	14.5	1.5 - 2.0	-	100
-	111701	-	111777	40 x 25	-	5	11.5	1.0 - 3.0	-	1500
-	057403062003	-	-	40 x 30	-	5	11.5	1.0 - 3.0	-	100
-	057452062003	-	-	45 x 20	-	5	11.5	1.5 - 2.0	-	100
-	057452562003	-	-	45 x 25	-	5	11.5	1.5 - 2.0	-	50
-	057501062003	-	-	50 x 10	-	3.5	11.5	0.8 - 2.0	-	50
-	057502062003	-	-	50 x 20	-	5	14.5	1.0 - 3.0	-	50
111415	111432	111449	111466	50 x 25	-	5	11.5	1.0 - 3.0	-	1000
-	057502562003	-	-	50 x 25	-	5	14.5	1.0 - 3.0	-	50
-	111434	-	111468	50 x 30	-	5	11.5	1.0 - 3.0	-	1000
-	057503062003	-	-	50 x 30	-	5	14.5	1.0 - 3.0	-	50
-	111702	-	-	50.8 x 31.8	2 x 1 1/4	5	11.5	1.0 - 3.0	11-20	1000
-	057503462003	-	-	50 x 34	-	5	14.5	1.0 - 3.5	-	50
-	057504062003	-	-	50 x 40	-	5	12	1.0 - 3.0	-	50
111416	111433	-	111467	50.8 x 25.4	2 x 1	5	11.5	1.0 - 3.0	10-18	1000
-	057553462003	-	-	55 x 34	-	5	14.5	1.5 - 4.0	-	25

CONTINUED ON NEXT PAGE

Ribbed Rectangular Inserts *CONTINUED*

SR 1550

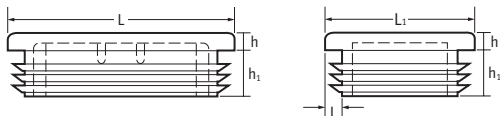

Part Number				Dimensions					Standard Pack Quantity	
Mid Grey		Dark Grey		L x L1 (mm)	L x L1 (ins)	h (mm)	h1 (mm)	l (mm)		l (gauge)
Polished	Eroded	Polished	Eroded							
-	111703	-	111779	60 x 20	-	5	14.5	1.0 - 3.0	-	1000
-	057602062003	-	-	60 x 20	-	5	14.5	1.5 - 2.0	-	25
-	057602562003	-	-	60 x 25	-	5	14.5	1.0 - 2.5	-	25
111418	-	111452	-	60 x 30	-	5	14.5	2.0 - 4.0	-	500
-	057603062003	-	-	60 x 30	-	5	14.5	1.0 - 2.5	-	25
111806	-	111808	-	60 x 40	-	5	14.5	1.0 - 3.0	-	500
111419	-	111453	-	60 x 40	-	5	14.5	2.0 - 4.0	-	500
-	057605062003	-	-	60 x 50	-	5	14.5	1.5 - 3.5	-	25
-	057703062003	-	-	70 x 30	-	5.7	17.7	1.0 - 2.0	-	25
-	057704062003	-	-	70 x 40	-	5	17.1	1.0 - 2.0	-	10
-	057705062003	-	-	70 x 50	-	5	14.5	1.0 - 2.0	-	10
-	111705	-	-	75 x 50	-	6	22	2.0 - 4.0	-	250
-	-	-	111782	76.2 x 50.8	3 x 2	6	22	2.0 - 4.0	8-14	250
-	057802062003	-	-	80 x 20	-	6	17.6	1.0 - 2.0	-	600
-	057803062003	-	-	80 x 30	-	5	14.5	1.0 - 2.5	-	500
-	057804062003	-	-	80 x 40	-	5	14.5	1.0 - 3.0	-	250
-	-	-	111471	80 x 40	-	5	14.5	2.0 - 4.0	-	250
-	057806062003	-	-	80 x 60	-	5	24	1.5 - 3.5	-	10
-	057807062003	-	-	90 x 50	-	6	21.5	2.0 - 4.5	-	10
-	057907062003	-	-	90 x 70	-	6	21.5	3.0 - 5.5	-	10
-	057809062003	-	-	100 x 30	-	5	14.5	1.5 - 3.5	-	25
-	057810062003	-	-	100 x 40	-	5	14.5	1.5 - 4.0	-	25
-	057811062003	-	-	100 x 50	-	5	24	2.0 - 3.0	-	10
-	057812062003	-	-	100 x 60	-	6	24.5	2.5 - 4.5	-	10
-	057813062003	-	-	100 x 80	-	6	24	3.0 - 5.5	-	10
-	057815062003	-	-	110 x 70	-	6	24	3.0 - 5.0	-	10
-	057903062003	-	-	120 x 30	-	5	14.5	1.5 - 2.0	-	10
-	057904062003	-	-	120 x 40	-	6	21.5	3.0 - 5.0	-	10
-	057905062003	-	-	120 x 50	-	6	21.5	3.0 - 5.5	-	10
-	111707	-	111783	120 x 60	-	6	22	2.0 - 4.0	-	10
-	057906062003	-	-	120 x 60	-	5	24.5	2.0 - 4.0	-	10
-	057908062003	-	-	120 x 80	-	5	24.5	2.0 - 3.0	-	10
-	057910062003	-	-	120 x 100	-	6	24	3.5 - 6.0	-	10
-	057912062003	-	-	140 x 80	-	5	24.5	2.0 - 4.5	-	10
-	057913062003	-	-	150 x 50	-	6	28	2.0 - 4.0	-	10
-	057914062003	-	-	150 x 100	-	7	27.5	3.0 - 8.0	-	10



CHECK OUT OUR
SOLUTIONS FOR
**FURNITURE
AND TRANSIT
PROTECTION**



**DISPLAY
LOCKS**

Pages 415-420



**SPRING
HINGES**

Pages 477-478



**FURNITURE
& DESIGN
CASTORS**

Pages 620-631



**GRIPNECK
FEET**

Pages 689



BUMPERS

Pages 690-703



**METAL
FASTENERS**

Pages 862-869

Call 0845 758 5070

www.essentracomponents.co.uk

Ribbed Rectangular Inserts CONTINUED

SR 1550

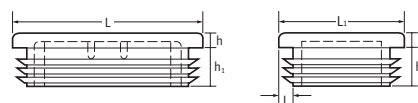

Part Number						Dimensions		Standard Pack Quantity
Yellow	Red	Green	Blue	Brown	Silver	L x L1 (mm)	l (mm)	
111859	111860	111861	111862	111863	803895	50.8 x 25.4	1.0 - 3.0	1000

Centrally-Notched Rectangular Inserts

SR 1550

LDPE

- Ideal for use with fixed-position bolts, screws and studs
- Spark-eroded finish
- To suit wall section 1.0-2.0mm

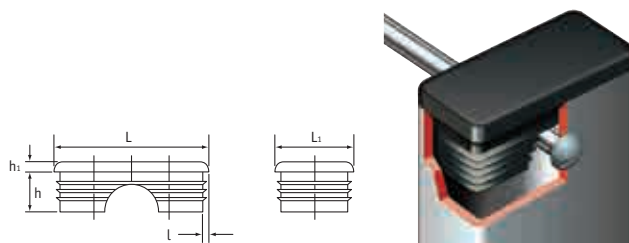

Part Number	Colour	Dimensions			Standard Pack Quantity
		L x L1 (mm)	h1 (mm)	h (mm)	
110721	Black	50.4 x 25.4	4.5	15.5	1000

Chrome-Plated Cap Rectangular Inserts

SR 1553

Black Polyethylene

- Ribbed for ease of insertion and positive fit
- Chrome-plated cap provides enhanced aesthetic appearance
- To suit wall section 1.0-2.0mm

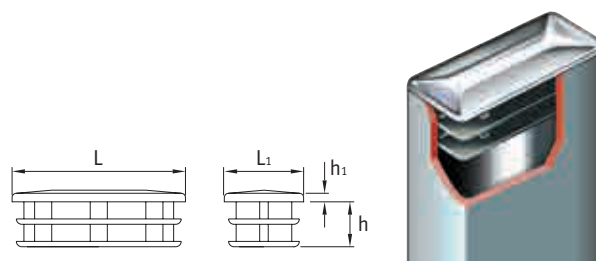

Part Number	Dimensions (mm)			Standard Pack Quantity
	L x L1	h	h1	
460966	20 x 10	10	1.5	1000
460967	20 x 15	10	2.0	1000
460968	30 x 15	10	2.0	1000
460969	40 x 20	11	2.0	1000

TUBE INSERTS

Chrome Rectangular Inserts

SR 5721

ABS

- Provides a neat finish
- High gloss chrome finished inserts
- Available in silver or black chrome finishes

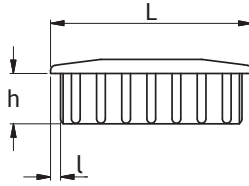

Part Number		Dimensions (mm)			Standard Pack Quantity
Silver Chrome	Black Chrome	L	l (mm)	h	
499199	-	20x10	1.0	9.0	100
-	499136	20x15	1.2	9.0	200
499128	499137	20x15	1.5	9.0	200
499200	-	30x20	1.2	9.0	100
499201	-	30x20	1.5	9.0	100
499129	499138	35x15	1.5	9.0	200
499130	499139	40x10	1.5	9.0	200
499131	-	40x20	1.2	9.0	100
499132	-	40x20	1.5	9.0	100
499133	-	50x30	1.5	10.0	100
499134	-	60x20	1.5	10.0	100
499135	-	80x20	2.0	10.2	100

Lightweight Rectangular Inserts

SR 1552

Black Polyethylene

- Ribbed for ease of insertion and positive fit
- Provide neat and attractive finish
- Gauge = 1.0-2.0mm

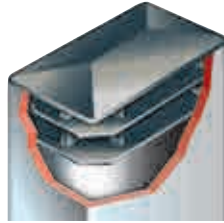
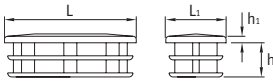

Part Number	Dimensions (mm)			Standard Pack Quantity
	L x L1 (mm)	h (mm)	h1 (mm)	
460936	10 x 20	9	3.0	4000
465474	10 x 40	10	3.0	2500
460937	15 x 20	10	3.5	3000
460939	15 x 30	10	3.5	3000
460942	15 x 40	10	3.5	2000
460940	20 x 30	10	4.0	4000
465473	20 x 40	11	4.0	2000
460944	25 x 40	12	4.0	2000
465475	25 x 50	12	4.0	1500
460945	30 x 40	13	5.0	1500
465472	30 x 50	13	5.0	1000
460950	30 x 100	16	3.0	500

Angled Rectangular Inserts

SR 1555

Black Polyethylene

- Easy assembly
- Durable and long lasting
- Perfect for tube ends on uneven surfaces and for tubes which meet surfaces at an angle

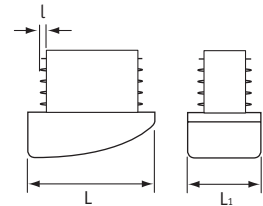
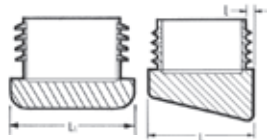

Metric

Part Number	Dimensions (mm)			Standard Pack Quantity
	L x L1 (mm)	l (mm)	Angle	
460769	20 x 15	1.0-2.0	10°	3000
460770	25 x 15	1.0-2.0	10°	4000
460771	30 x 15	1.0-2.0	10°	1000
10450	30 x 20	1.0-1.5	15°	2500
10451	40 x 20	1.0-1.5	20°	1250

Special Pattern (Metric)

Part Number	Dimensions (mm)		Colour	Standard Pack Quantity
	L x L1	l		
111564	50 x 25	1.2-2.0	Black	400

Ribbed Oval Inserts

SR 1557

Black Polyethylene

- Easy assembly
- Spark-eroded surface unless otherwise stated
- Secure fixing
- Straight sides
- Mid Grey similar to RAL 7042
- Dark Grey similar to RAL 7011

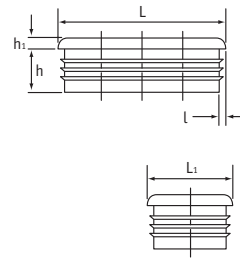

Flat Oval (Metric)

Part Number				Dimensions				Standard Pack Quantity
Black	White	Dark Grey	Mid Grey	L x L1 (mm)	h (mm)	h1 (mm)	l (gauge)	
460794*	-	-	-	20 x 10	10.0	5	1.5-2.0	4000
145201069903	145201060303	-	-	20 x 10	11.5	5	1.5-2.0	250
111556	111632	111786	111708	30 x 15	-	-	0.8-2.0	3000
460796	-	-	-	35 x 15	-	-	1.2-2.5	3000
145351569903	145351560303	-	145351562003	35 x 15	11.5	5	1.2-2.5	250
460797	-	-	-	35 x 20	-	-	1.0-3.0	2500
145352069903	145352060303	-	145352062003	35 x 20	11.5	5	1.5-2.0	250
465578	-	-	-	38 x 20	-	-	1.0-3.0	2500
145382069903	145382060303	-	145382062003	38 x 20	11.5	5	1.0-3.0	250
145402069903	145402060303	-	145402062003	40 x 20	11.5	4	1.5-2.0	100
111558	111634	-	111710	40 x 20	-	-	1.0-3.0	2500
145482069903	145482060303	-	145482062003	48 x 20	11.5	5	1.5-2.0	100
460800	-	-	-	50 x 20	-	-	1.0-3.0	1500
145502069903	-	-	145502062003	50 x 20	11.5	5	1.0-3.0	100
465579	-	-	-	50 x 25	-	-	1.0-2.5	1250
145502569903	145502560303	-	145502562003	50 x 25	11.5	5	1.0-2.5	50
465580	-	-	-	50 x 30	-	-	1.0-2.5	1000
145503069903	145503060303	-	145503062003	50 x 30	11.5	5	1.0-2.5	50
465581	-	-	-	60 x 20	-	-	1.0-2.0	1000
465582	-	-	-	60 x 30	-	-	1.0-2.0	750

* Polished

Imperial

Part Number	Dimensions				Standard Pack Quantity
Black	L x L1 (mm)	h (mm)	h1 (mm)	l (gauge)	
111557	1 3/4 x 3/8	11.5	3.5	11-20	3000

Chrome Oval Inserts

SR 1558

Black Polyethylene

- Add attractive finish to high-quality tubular products
- Chrome-plated cap provides enhanced appearance
- Ribbed for ease of entry and positive fit
- Fit gauge 1.0-1.5mm

Part Number	Dimensions (mm)			Standard Pack Quantity
	L x L1 (mm)	h (mm)	h1 (mm)	
1348190	20 x 10	10	2.0	3000
463024	30 x 15	10	2.5	3000
465360	40 x 20	10	3.0	500

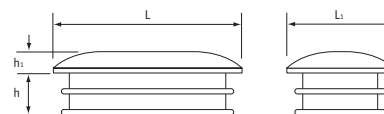

Angled Oval Inserts

SR 1555

Black Polyethylene

- Durable and long lasting
- Perfect for tube ends which meet surfaces at an angle

Part Number	Dimensions (mm)		Angle	Standard Pack Quantity
	L x L1 (mm)	l (mm)		
465327	30 x 15	1.2-1.5	12.5°	1000
465326	30 x 15	1.2-1.5	30.0°	2000

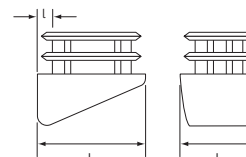

Chrome Oval Insert

SR 5732

ABS

- Chrome finished inserts for enhanced aesthetic appearance
- Ideal for popular size gauges of oval tubing

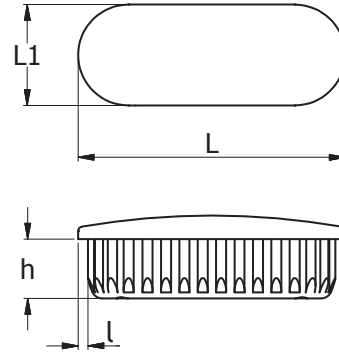

Part Number	Dimensions (mm)			Standard Pack Quantity
	L	l	h	
499218	20 x 10	1.2	9.0	100
499219	25 x 10	1.5	9.0	100
499220	25 x 15	1.5	9.0	100
499221	30 x 15	1.2	10.0	100
499222	30 x 15	1.5	10.0	100
499223	30 x 20	1.2	10.0	100
499228	45 x 17	1.5	10.0	100

TRY BEFORE YOU BUY – REQUEST YOUR FREE SAMPLES TODAY

Call **0845 758 5070** or visit www.essentracomponents.co.uk

Spring Threaded Insert

SR 1430

- Spring loaded insert for round and square tubes
- Quick fit application

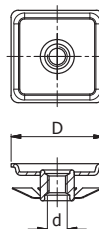
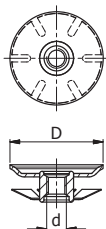

Round

Part Number	D (mm)	Thread Size (d)	Gauge (mm)	Standard Pack Quantity
499455	19.0	M6	1.0	200
499456	22.0	M6	1.0	200
499457	25.0	M6	1.0	200
551836	51.0	M6	1.2	200
499458	25.0	M8	1.2	200
499460	32.0	M8	1.2	200
499461	38.0	M8	1.2	200
551837	51.0	M8	1.2	200
551838	25.0	M10	1.2	200
499463	32.0	M10	1.5	200
499464	38.0	M10	1.5	200
551839	51.0	M10	1.5	200

Square

Part Number	D (mm)	Thread Size (d)	Gauge (mm)	Standard Pack Quantity
499465	19 x 19	M6	1.0	200
499466	22 x 22	M6	1.0	200
499467	25 x 25	M6	1.0	200
551845	25 x 25	M8	1.2	200
499470	32 x 32	M8	1.2	200
499471	38 x 38	M8	1.2	200
551842	22 x 22	M10	1.5	200
551843	25 x 25	M10	1.5	200
499473	32 x 32	M10	1.5	200
499474	38 x 38	M10	1.5	200

Spring Threaded Tube Connectors

SR 1430

- Knock-in insert for connecting tubes
- Threaded for secure screw fixing

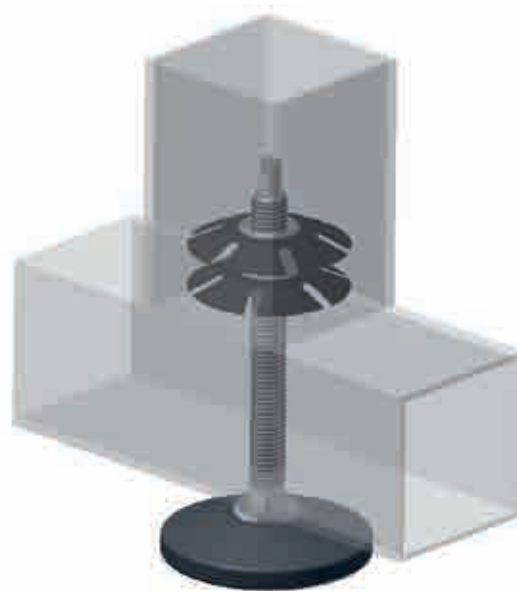
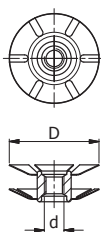

Part Number	D (mm)	Thread Size (d)	Gauge (mm)	Standard Pack Quantity
499444	19	M6	1.0	200
499445	22	M6	1.0	200
499446	25	M6	1.0	200
499447	25	M8	1.2	200
499449	32	M8	1.2	200
499450	38	M8	1.2	200
499451	25	M10	1.5	200
499453	32	M10	1.5	200
499454	38	M10	1.5	200
551835	51	M10	1.5	200

THREADED INSERTS

Horizontal Inserts for Square Tubes

SR 5731

Nylon

- Horizontal inserts with various options for joining square tubes

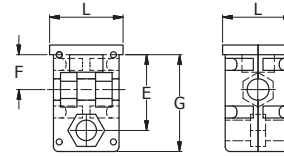

Type 1 - 2 level, 4 direction



Type 2 - 1 level, 2 direction



Type 3 - 2 level, 4 direction, top thread



Type 4 - 2 level, 4 direction, bottom thread



Type 5 - 2 level, 4 direction, 2 threads

Part Number	Dimensions (mm)							Number of Nuts	Standard Pack Quantity
	L	Thread Size	Type	Wall Thickness	E	F	G		
499229	25 x 25	M8	1	1.5	12.5	27	43	0	600
499230	25 x 25	M10	1	1.5	12.5	30	42	0	350
499231	30 x 30	M10	1	1.25	15	33	43	0	200
499232	30 x 30	M8	1	1.5	15	32	40	0	150
499233	30 x 30	M8	1	2	15	33	41	0	250
499234	30 x 30	M10	1	2	15	33	43	0	250
499245**	40 x 40	M10	2	2	25	-	40	1	100
499246**	40 x 40	M12	2	2	25	-	40	1	50
499238	25 x 25	M8	3	1.5	12.5	27	43	1	100
499239 *	25 x 25	M8	3	1.5	12.5	27	43	1	100
499240	25 x 25	M10	3	1.5	12.5	30	42	1	100
499241	30 x 30	M10	3	1.25	15	33	43	1	100
499242	30 x 30	M8	3	1.5	15	32	40	1	100
499244	30 x 30	M10	3	2	15	33	43	1	100
499247	25 x 25	M8	4	1.5	12.5	27	43	1	100
499250	30 x 30	M8	4	2	15	33	41	1	100
499251	30 x 30	M10	4	2	15	33	43	1	50
499252	25 x 25	M8	5	1.5	12.5	27	43	2	100
499253	25 x 25	M10	5	1.5	12.5	30	42	2	100
499256	30 x 30	M10	5	2	15	33	43	2	50

*With DIN 985 locknut **Domed Head

Horizontal Inserts for Rectangular Tubes

SR 1421

Nylon

- Horizontal inserts with various options for joining rectangular tubes

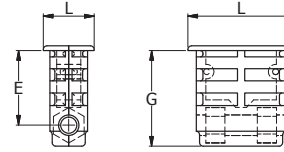

Type 1 - 1 level, 2 direction



Type 2 - 1 level, 2 direction, top thread



Type 3 - 1 level, 2 direction, bottom thread



Type 4 - 1 level, 2 direction, 2 threads

Part Number	Dimensions (mm)							Number of Nuts	Standard Pack Quantity
	L	Thread Size	Type	Wall Thickness	E	F	G		
499258	40 x 20	M8	1	1.5	30	-	41	0	200
499259	40 x 25	M8	1	1.5	30	-	41	0	150
499260	45 x 25	M10	1	2	20	-	39	0	100
499262	50 x 30	M10	1	1.5	30	-	32	0	250
499264	60 x 30	M10	1	2	20	-	33	0	100
499265	30 x 20	M8	2	1.5	15	-	37	1	100
499266*	30 x 20	M8	2	2	15	-	36	1	100
499268	40 x 20	M8	3	1.5	30	-	41	1	100
499271	40 x 25	M8	3	1.5	30	-	41	1	100
499274	50 x 30	M10	3	1.5	30	-	42	1	100
499275*	50 x 30	M10	3	2	20	-	31	1	100
499276	60 x 30	M10	3	2	20	-	33	1	100
499277	30 x 20	M8	4	1.5	15	-	37	2	100
499278	40 x 20	M8	4	1.5	30	-	41	2	100
499279	40 x 25	M8	4	1.5	30	-	41	2	100
499280	45 x 25	M10	4	2	20	-	39	2	100
499281*	50 x 25	M10	4	2	20	-	32	2	100
499282	50 x 30	M10	4	1.5	30	-	42	2	50
499284	60 x 30	M10	4	2	20	-	33	2	50

* Domed Head

Threaded Inserts

SR 1570

- Can be used with either adjustable feet (SR 1572) or adjustable tilt glides (SR 1575)
- M8 and M10 thread sizes available for Type 2
- Suitable for wall thickness of 1.0-2.0mm

Material Key

PP = Polypropylene

HIPS = High-Impact Polystyrene

LDPE = Low-Density Polyethylene

HDPE = High-Density Polyethylene

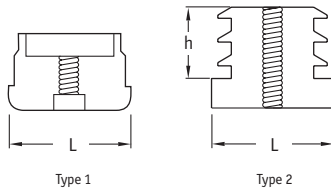

Square – Type 1 (Imperial) (Thread Size M8)

Part Number		Dimensions		Material	Standard Pack Quantity
16 Gauge	18 Gauge	L (ins)	L (mm)		
-	39768	¾	19.0	HIPS	4000
199412	199412	1	25.4	Nylon	1250
462389	-	1¼	31.7	HIPS	500
-	462390*	1½	38.1	HIPS	250
462391*	-	1½	38.1	HIPS	250

*Thread size M10

Round – Type 1 (Imperial) (Thread Size M8)

Part Number		Dimensions		Material	Standard Pack Quantity
16 Gauge	18 Gauge	L (ins)	L (mm)		
-	39762	¾	19.0	Nylon	1000

Square – Type 2 (Metric)

Part Number	Dimensions (mm)		Thread Size	Material	Standard Pack Quantity
	L	h			
498637	15	18	M8	HDPE	1000
498638	16	18	M8	HDPE	1000
498640	20	18	M8	HDPE	1000
498641	22	18	M8	HDPE	1000
498642	25	19	M8	HDPE	500
498643	25	19	M10	HDPE	1000
498644	30	20	M8	HDPE	250
498645	30	20	M10	HDPE	250
498646	35	21	M10	HDPE	250
498647	40	22	M10	HDPE	500
498649	50	30	M8	HDPE	250
498648	50	30	M10	HDPE	250

Rectangular – Type 2 Metric

Part Number	Dimensions (mm)		Thread Size	Material	Standard Pack Quantity
	L	h			
499807	20 x 30	19	M10	HDPE	1000
498613	20 x 40	19	M8	HDPE	1000
498610	20 x 35	19	M8	HDPE	1000
499806	20 x 40	19	M10	HDPE	1000
498612	20 x 35	19	M10	HDPE	1000
498614	20 x 50	19	M10	HDPE	500
498615	20 x 50	19	M10	HDPE	500
498618	20 x 60	19	M8	HDPE	500
498617	25 x 50	22	M8	HDPE	500
498616	25 x 50	22	M10	HDPE	500
462385*†	60 x 30	16	M10	LDPE	250

*Plain Shank †Wall thickness 2.0mm only

Round – Type 2 Metric

Part Number	Dimensions (mm)		Thread Size	Material	Standard Pack Quantity
	L	h			
462371	16	34	M6	Nylon	3500
462372	16	34	M8	Nylon	3500
498619	18	18	M8	HDPE	1000
498620	20	18	M8	HDPE	1000
499809	20	19	M10	PP	2000
498621	22	19	M8	HDPE	1000
498622	22	19	M10	HDPE	500
462375	25	33	M6	Nylon	1000
498623	25	19	M8	HDPE	1000
498624	25	19	M10	HDPE	500
498626	28	19	M8	HDPE	500
498628	30	19	M8	HDPE	1000
498627	30	19	M10	HDPE	1000
498630	32	18	M8	HDPE	250
498629	32	19	M10	HDPE	1000
462377	38	25	M10	Nylon	650
466561	38	38	M8	HDPE	250
498633	40	19	M10	PP	250
498632	40	20	M10	HDPE	250
498634	45	21	M10	HDPE	500
498635	50	20	M8	HDPE	250
498636	50	21	M10	HDPE	500

THREADED INSERTS

Metal-Threaded Inserts - Standard

SR 1571

HDPE with Steel Nut

- Standard-duty insert
- Ideal for use with adjustable feet, tilt glides and castors
- Metal thread allows smooth repeatable adjustment
- Grey threaded inserts are RAL 7042

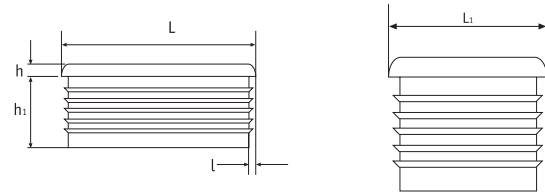

Round



Square



Rectangular

Round

Part Number		Dimensions (mm)				Thread Size	Standard Pack Quantity
Grey	Black	L	h	h1	l (gauge)		
551742	498560	19	5	20	1.0-1.5	M6	1000
551747	498561	20	5	20	1.0-1.5	M6	1000
551725	498562	20	5	20	1.0-1.5	M8	1000
551727	498563	25	5	20	1.0-1.5	M6	500
551726	498564	25	5	20	1.0-1.5	M8	1000
551735	498565	30	5	20	1.0-1.5	M8	500
551730	498566	30	5	20	1.0-1.5	M10	500
551731	498567	32	5	20	1.0-1.5	M8	500
-	498568	32	5	20	1.0-1.5	M10	1000
-	498569	35	5	20	1.0-1.5	M8	500
551733	498570	35	5	20	1.0-1.5	M10	250
551734	498571	38	5	20	1.0-1.5	M8	250
-	498572	38	5	20	1.0-1.5	M10	500
-	498573	38	5	20	1.0-1.5	M12	500
551723	498574	40	5	20	1.0-1.5	M8	250
551738	498575	40	5	20	1.0-1.5	M10	250
-	498576	40	5	20	1.0-1.5	M12	500
551721	498577	50	5	20	1.0-1.5	M8	100
551729	498578	50	5	20	1.0-1.5	M10	500
551746	498579	50	5	20	1.0-1.5	M12	100
551748	498580	60	5	20	1.0-1.5	M8	250
551739	498581	60	5	20	1.0-1.5	M10	100
-	498582	60	5	20	1.0-1.5	M12	100

Square

Part Number		Dimensions (mm)				Thread Size	Standard Pack Quantity
Grey	Black	L	h	h1	l (gauge)		
551745	498583	19	5	20	1.0-1.5	M6	1000
-	498584	20	5	20	1.0-1.5	M6	1000
-	498585	20	5	20	1.0-1.5	M8	1000
551724	498586	25	5	20	1.0-1.5	M6	500
551717	498587	25	5	20	1.0-1.5	M8	500
551719	498588	30	5	20	1.0-1.5	M8	1000
551718	498589	30	5	20	1.0-1.5	M10	250
-	498590	35	5	20	1.0-1.5	M8	500
551743	498591	35	5	20	1.0-1.5	M10	500
551716	498592	40	5	20	1.0-1.5	M8	200
551715	498593	40	5	20	1.0-1.5	M10	500
551740	498594	40	5	20	1.0-1.5	M12	500
551720	498595	50	5	20	1.0-1.5	M8	100
551732	498596	50	5	20	1.0-1.5	M10	250
-	498597	50	5	20	1.0-1.5	M12	250

Rectangular

Part Number		Dimensions (mm)				Thread Size	Standard Pack Quantity
Grey	Black	L x L1	h	h1	l (gauge)		
551741	498598	30 x 20	5	20	1.0-1.5	M8	500
-	498599	30 x 20	5	20	1.0-1.5	M10	1000
551737	498600	40 x 20	5	20	1.0-1.5	M8	250
551749	498601	40 x 20	5	20	1.0-1.5	M10	500
-	498602	40 x 30	5	20	1.0-1.5	M8	500
-	498603	40 x 30	5	20	1.0-1.5	M10	500
-	498604	50 x 25	5	20	1.0-1.5	M8	250
551744	498605	50 x 25	5	20	1.0-1.5	M10	500
-	498606	50 x 30	5	20	1.0-1.5	M8	200
551736	498607	50 x 30	5	20	1.0-1.5	M10	500
551728	498608	60 x 30	5	20	1.0-1.5	M8	250
551722	498609	60 x 30	5	20	1.0-1.5	M10	250

Metal-Threaded Inserts

SR 1571

Black Nylon 6 or HDPE

- Heavy-duty insert
- Ideal for use with adjustable feet, tilt glides and castors
- M8 or M10 thread with mild steel holding nut provides strong fixing
- Metal thread allows smooth repeatable adjustment
- Two-piece mouldings fit neatly together to fit into tubes

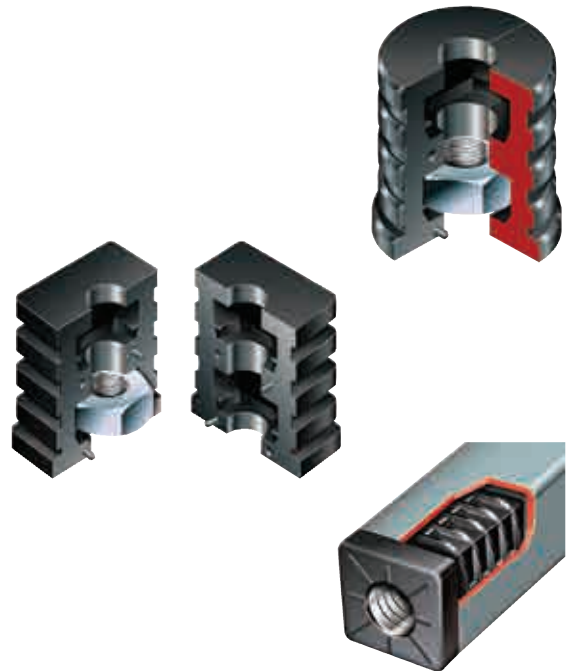
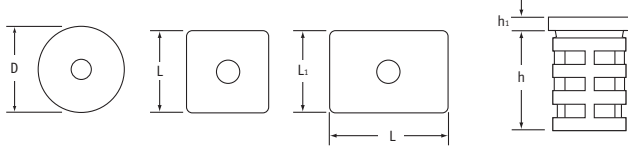

Nylon Round Inserts (two piece moulding)

Part Number	Thread Size	Dimensions (mm)				Standard Pack Quantity
		Gauge	D	h1	h	
461361	M8	1.5	25	5	35	750
461367	M8	2.0	30	5	35	500
461368	M8	2.0	32	5	35	500
461369	M8	2.0	40	5	35	300
461362	M10	1.5	25	5	35	600
461370	M10	2.0	30	5	35	500
461371	M10	2.0	32	5	35	500
461363	M10	1.5	35	5	35	350
461372	M10	2.0	35	5	35	300
461364	M10	1.5	38	5	38	300
461365	M10	1.5	40	5	34	300
461373	M10	2.0	40	5	35	300
461366	M10	1.5	50	5	35	200
461374	M10	2.0	50	5	35	200

Nylon Square Inserts (two piece moulding)

Part Number	Thread Size	Dimensions (mm)				Standard Pack Quantity
		Gauge	L	h1	h	
461351	M8	1.5	20	5	35	500
461352	M8	1.5	25	5	35	500
461353	M8	1.5	30	5	35	400
461357	M8	2.0	30	5	35	400
461354	M10	1.5	25	5	35	500
461355	M10	1.5	30	5	35	400
461358	M10	2.0	30	5	35	400
461359	M10	2.0	35	5	35	400
461356	M10	1.5	40	5	37	320
461360	M10	2.0	40	5	35	320

Nylon Rectangular Inserts (two piece moulding)

Part Number	Thread Size	Dimensions (mm)				Standard Pack Quantity
		Gauge	L x L1	h1	h	
461375	M8	1.5	40 x 20	5	35	500
461376	M10	2.0	50 x 25	5	35	350

HDPE Square Inserts

Part Number	Dimensions (mm)			Standard Pack Quantity
	L	Gauge	Thread Size	
PZMN300-1020M8	30	1.0 - 2.0	M8	500
PZMN300-1020M10	30	1.0 - 2.0	M10	500
PZMN400-RM10B	40	1.0 - 2.0	M10	250

HDPE Round Inserts

Part Number	Dimensions (mm)		Thread Size	Standard Pack Quantity
	D	Gauge		
PZMR250-15RM10B	25	1.5	M10	500

Extra Long HDPE Square Inserts

Part Number	Dimensions (mm)			Thread Size	Standard Pack Quantity
	L	Gauge			
PZML250-RM08B	25	1.0 - 2.0	M8	500	
PZML250-RM10B	25	1.0 - 2.0	M10	250	
PZML300-RM10B	30	1.0 - 2.0	M10	250	

Threaded Metal Bush HDPE Square Inserts

Part Number	Dimensions (mm)		Thread Size	Standard Pack Quantity
	L	Gauge		
PZMS200-RM08B	20 x 20	1.0 - 2.0	M8	1000
PZMS250-RM08B	25 x 25	1.0 - 2.0	M8	500
PZMS250-RM10B	25 x 25	1.0 - 2.0	M10	500

THREADED INSERTS

All-Metal Threaded Inserts

SR 1567

Cast Aluminium Alloy

- For heavy-duty applications



Round (Metric)

Part Number	Tube Size (mm)	Gauge (mm)	Thread Size	Standard Pack Quantity
PZAR320-15M10	32	1.5	M10	500
PZAR320-2M10	32	2.0	M10	500

Square (Metric)

Part Number	Tube Size (mm)	Gauge (mm)	Thread Size	Standard Pack Quantity
PZAS250-15M10	25 x 25	1.5	M10	400
PZAS250-2M10	25 x 25	2.0	M10	400
PZAS300-15M10	30 x 30	1.5	M10	400
PZAS300-2M10	30 x 30	2.0	M10	400
PZAS400-15M10	40 x 40	1.5	M10	200
466585	40 x 40	2.0	M10	100
466584	40 x 40	2.5	M10	100

Rectangular (Metric)

Part Number	Tube Size (mm)	Gauge (mm)	Thread Size	Standard Pack Quantity
PZAT500250-2M10	50 x 25	2.0	M10	300
PZAT500300-2M10	50 x 30	2.0	M10	250
PZAT600300-2M10	60 x 30	2.0	M10	200
PZAT600300-25M1	60 x 30	2.5	M10	200

All-Metal Threaded Inserts - Steel

SR 1567

Steel

- For heavy-duty applications



Round (Imperial)

Part Number	Tube Size (mm)	Tube Size (ins)	Gauge (mm)	Gauge	Thread Size	Standard Pack Quantity
PZFR254-16M10	25.4	1	1.6	16	M10	500
PZFR317-16M10	31.7	1¼	1.6	16	M10	250

Square (Imperial)

Part Number	Tube Size (mm)	Tube Size (ins)	Gauge (mm)	Gauge	Thread Size	Standard Pack Quantity
PZFL254-18M08*	25.4 x 25.4	1 x 1	1.2	18	M8	500
PZFS254-16M10	25.4 x 25.4	1 x 1	1.6	16	M10	250

*Light-duty style threaded, no bush.

Hinged Threaded Insert

SR 1570

Black Nylon 6

- Insert into metal panel
- Use in conjunction with M8 adjustable foot or tilt glide

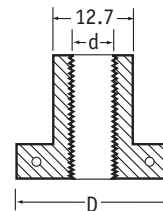

Part Number	Dimensions (mm)		Standard Pack Quantity
	d	D	
199479	8	20	5000

Heavy Duty Square Threaded Inserts

SR 5437

Nylon with Nickel Plated Brass or Stainless Steel Inserts

- Interference fit
- Designed for use with machine feet
- Heavy duty for high load capacity

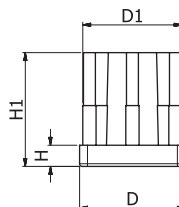

Part Number		Gauge (mm)	Thread Size	Dimensions (mm)				Maximum Static Load N	Standard Pack Quantity
Nickel Plated Brass Insert	Stainless Steel Insert			D	D1	H	H1		
493605	493622	1.5	M10	30	27.5	6	33	5500	24
493606	493623	1.5	M12	30	27.5	6	33	5500	24
493607	493624	1.5	M16	30	27.5	6	33	5500	24
493608	493625	1.5	M10	40	37.5	8	43	8000	24
493609	493626	1.5	M12	40	37.5	8	43	8000	24
493610	493627	1.5	M16	40	37.5	8	43	8000	24
493611	-	1.5	M20	40	37.5	8	43	8000	24
493612	493629	2.0	M10	40	36.5	8	43	8000	24
493613	493630	2.0	M12	40	36.5	8	43	8000	24
493614	493631	2.0	M16	40	36.5	8	43	8000	24
493615	493632	2.0	M20	40	36.5	8	43	8000	24
493616	493633	1.5	M12	50	47.5	10	55	9500	16
493617	493634	1.5	M16	50	47.5	10	55	9500	16
493618	-	1.5	M20	50	47.5	10	55	9500	16
493619	493636	2.0	M12	50	45.5	10	55	9500	16
493620	493637	2.0	M16	50	45.5	10	55	9500	16
-	493638	2.0	M20	50	45.5	10	55	9500	16

Heavy Duty Round Threaded Inserts

SR 5438

Nylon with Nickel Plated Brass or Stainless Steel Inserts

- Interference fit
- Designed for use with machine feet
- Heavy duty for high load capacity

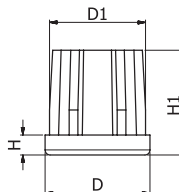

Part Number		Gauge (mm)	Thread Size	Dimensions (mm)				Maximum Static Load N	Standard Pack Quantity
Nickel Plated Brass Insert	Stainless Steel Insert			D	D1	H	H1		
493639	493656	1.0	M10	30	28.5	6	35	3200	24
493640	493657	1.0	M12	30	28.5	6	35	3200	24
493641	-	1.0	M16	30	28.5	6	35	3200	24
493642	493658	1.5	M10	38	35.5	8	43	5500	24
493643	493659	1.5	M12	38	35.5	8	43	5500	24
-	493660	1.5	M16	38	35.5	8	43	5500	24
493645	-	1.5	M10	42	39.5	8	42	6500	24
493646	493661	1.5	M12	42	39.5	8	42	6500	24
-	493662	1.5	M16	42	39.5	8	42	6500	24
493648	493663	1.5	M20	42	39.5	8	42	6500	24
493649	-	1.5	M10	48	45.5	11	49	8000	24
493650	493664	1.5	M12	48	45.5	11	49	8000	24
-	493665	1.5	M16	48	45.5	11	49	8000	24
493652	493666	1.5	M20	48	45.5	11	49	8000	24
493653	493667	1.5	M12	50	47.5	11	49	8500	24
493654	493668	1.5	M16	50	47.5	11	49	8500	24
493655	493669	1.5	M20	50	47.5	11	49	8500	24

TUBE CONNECTORS

Hinged Tube Connectors

SR 1532

Black Nylon

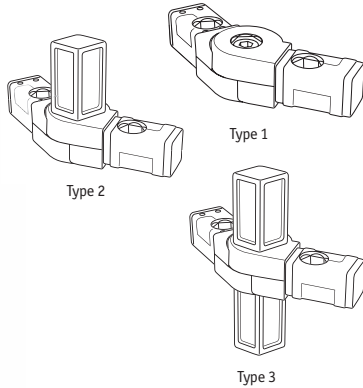

Part Number	Type	Tube Size (mm)	Angle Range (degrees)	Standard Pack Quantity
463683	1	25	45-195	200
463684*	1	25	45-195	200
463685	1	30	45-200	100
463686	2	25	45-195	100
463687*	2	25	45-195	100
463688	2	30	45-200	80
463689	3	25	45-195	100
463690*	3	20	45-195	100
463691	3	30	45-200	80

*24 locking positions for secure fixing

Clinch Fittings

SR 1633

Steel or Bright Zinc Plated

- Convenient and strong way to join tubes at right angles
- Use a spanner to compress fitting before insertion
- Set with hammer; drill and add rivet if required
- Type 2 requires two pieces per joint

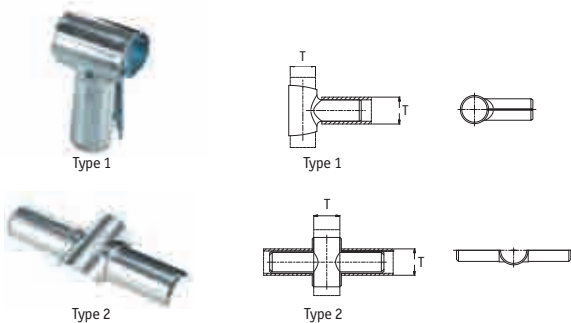

Part Number		Type	Dimensions (imperial)		Dimensions (metric)		Standard Pack Quantity
Steel	BZP		Tube Size (T)	Gauge	Tube Size (T)	Gauge	
1220459	1220463	1	1	16	25.4	1.63	20
1220460	1220464	1	1.25	16	31.75	1.63	20
1220461	1220465	2	1	16	25.4	1.63	20
1220462	1220466	2	1.25	16	31.75	1.63	20

Hose & Tube Connectors

SR 1935

Natural HDPE

- Ideal for both plastic and rubber flexible tubing



Part Number	Type	For tube with I/D (mm)	Standard Pack Quantity
12828	T-Shape	6.0	10000
199053	Y-Shape	11.0	2000

Saddle Tube Connector

SR 5747

Black Nylon 6.6

- A solid T connection is created by using an M6 screw (not included)
- Suitable for furniture, constructions, stand builders and machinery

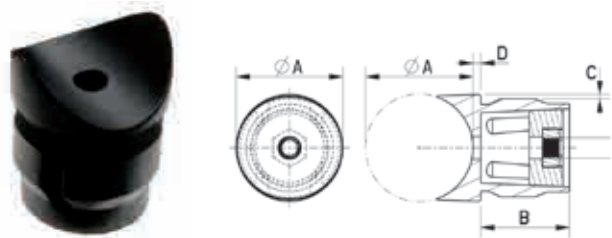

Part Number	Dimensions (mm)				Standard Pack Quantity
	A	B	C	D	
146001011401	15	20	1	2	25
146002511401	16	20	1	2	25
146003011401	18	20	1	2	25
146003511401	20	20	1	2	25
146004011401	22	20	1	2	25
146004511401	25	26	1	2	25
146005011401	26	26	1	2	25
146006011401	28	26	1	2	25
146006511401	30	26	1	2	25
146007011401	32	26	1	2	25

Multi-Way Tube Connectors for Square Tubes

SR 1509

Nylon with or without Steel Core

- Now available in Black or Grey

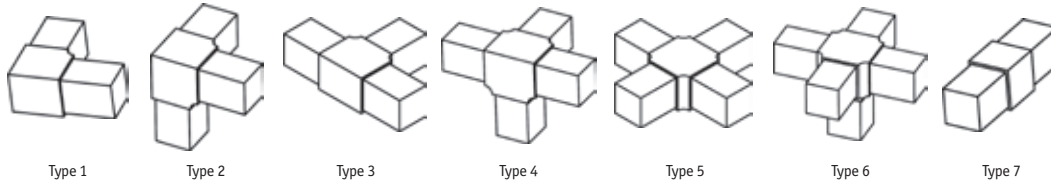

Nylon

Part Number		Dimensions		Type	Standard Pack Quantity
Black	Grey	Tube Size (mm)	Gauge (mm)		
463704	-	20	1.5	1	750
463705	-	20	1.5	2	300
490981	-	20	1.5	3	500
463706	-	20	1.5	4	250
490982	-	20	1.5	5	350
463707	-	20	1.5	6	50
490991	-	20	1.5	7	900
461347	-	25	1.5	1	250
461348	550298*	25	1.5	2	100
CIT-250-15-3WFN	550296*	25	1.5	3	250
461349	-	25	1.5	4	75
490983	550297*	25	1.5	5	150
461350	550300*	25	1.5	6	50
464538	-	25	1.5	7	300
461910	-	30	2.0	1	150
461911	-	30	2.0	2	100
490984	-	30	2.0	3	100
461912	-	30	2.0	4	75
490985	-	30	2.0	5	100
461913	-	30	2.0	6	50
490993	-	30	2.0	7	250

Black Nylon with Metal Core

Part Number	Dimensions		Type	Standard Pack Quantity
	Tube Size (mm)	Gauge (mm)		
463708	20	1.5	1	200
463709	20	1.5	2	50
490986	20	1.5	3	200
463710	20	1.5	4	50
490987	20	1.5	5	150
463711	20	1.5	6	50
490992	20	1.5	7	50
CIT-250-15-2W	25	1.5	1	100
CIT-250-15-3WC	25	1.5	2	50
CIT-250-15-3WF	25	1.5	3	50
CIT-250-15-4W	25	1.5	4	50
CIT-250-15-4WF	25	1.5	5	50
CIT-250-15-5W	25	1.5	6	50
462364	25	1.5	7	100
CIT-300-02-2W	30	2.0	1	100
CIT-300-02-3WC	30	2.0	2	75
490988	30	2.0	3	120
CIT-300-02-4W	30	2.0	4	50
490989	30	2.0	5	60
490990	30	2.0	6	90
462365	30	2.0	7	75

NB: Connectors are supplied in two parts, held together when fitted, with the exception of codes marked *, which come in one piece.

Multi-Way Tube Connectors for Round Tubes

SR 1503

Black PE or Nylon

- Ideal for popular sizes of round tubing

Imperial without Metal Core (PE)

Part Number	To Fit Tube Size		Type	Standard Pack Quantity
	Dia (ins)	Gauge		
10712*	3/4	1/16	1	2000
199470	7/8	20	1	1000
600953	1	18	1	500
199469	1 1/4	20	1	500

* High-density polyethylene.

Metric with Metal Core (Nylon)

Part Number	Dimensions		Type	Standard Pack Quantity
	Tube Size (mm)	Gauge (mm)		
463696	20	1.5	1	325
463698	25	1.5	1	250
463700	30	1.5	1	125
463694	32	1.0	2	50
463702	32	1.5	1	125

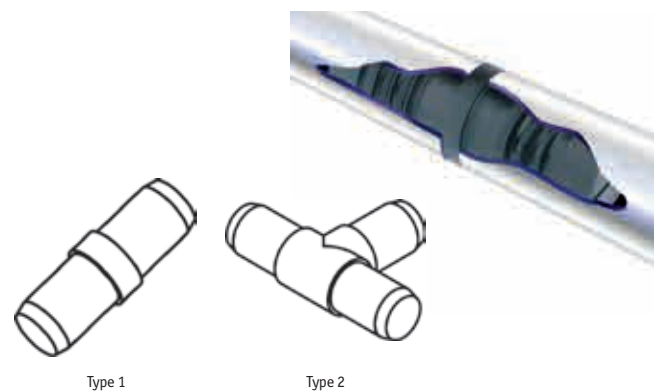

Metric without Metal Core (Nylon)

Part Number	Dimensions		Type	Standard Pack Quantity
	Tube Size (mm)	Gauge (mm)		
463697	20	1.5	1	1200
463693	20	1.0	2	120
463699	25	1.5	1	800
463701	30	1.5	1	500
463703	32	1.5	1	400

TUBE CONNECTORS

Round Expanding Tube Connectors

SR 6428

Nylon

- Male and female parts sold separately
- Both male and female parts screw together, the screw and nut tighten to hold in place
- Male connectors have a stainless steel bolt
- Female connectors have a stainless steel nut

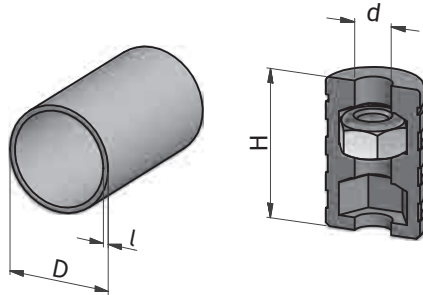

Female part (with nut)

Part Number	Dimensions (mm)				Standard Pack Quantity
	D	l (Gauge)	H	d	
551759	16	1.0	42	M6	800
550307	19	1.5	39	M6	800
550314	20	1.0	42	M8	400
551766*	20	2.0	42	M8	400
551761	22	1.5	42	M6	600
550318	22	1.0	42	M8	400
550321	22	1.2	42	M8	400
550309	25	1.5	42	M6	600
550325	25	1.5	42	M8	350
550308	28	1.5	41	M6	300
550329	28	2.0	42	M8	300
551763	30	2.0	35	M6	300
550333	30	1.5	42	M8	300
550337	30	2.0	42	M8	300
550341	30	1.5	42	M10	200
551770	32	1.5	42	M10	200
550345	35	1.5	42	M10	200
551772	35	2.0	43	M10	250
550349	38	1.2	42	M10	150

Male part (with bolt)

Part Number	Dimensions (mm)			Thread Length	Thread Size	Standard Pack Quantity
	D	l (Gauge)	H			
551758	16	1.0	42	30	M6	800
550304	19	1.5	39	30	M6	800
551764	20	1.0	42	30	M8	400
551765*	20	2.0	42	30	M8	400
551760	22	1.5	42	30	M6	600
550317	22	1.0	42	30	M8	400
550320	22	1.2	42	30	M8	400
550306	25	1.5	42	30	M6	600
550324	25	1.5	42	30	M8	350
550305	28	1.5	41	30	M6	300
550328	28	2.0	42	30	M8	300
551762	30	2.0	35	30	M6	300
550332	30	1.5	42	30	M8	300
550336	30	2.0	42	30	M8	300
550340	30	1.5	42	30	M10	200
551769	32	1.5	42	30	M10	200
550344	35	1.5	42	30	M10	200
551771	35	2.0	43	30	M10	200
550348	38	1.2	42	30	M10	150

*Parts do not fit the saddle connectors

Saddle Connectors

- Suitable for the M8 range of expander connectors (SR 6428)
- Fits to the top of the connector to attach a horizontal tube

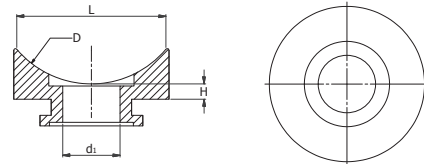

Part Number	Dimensions (mm)				Standard Pack Quantity
	L	d1	H	D	
550437	22	M8	2	13.5	500
550438	28	M8	2	13.5	500

Square Expanding Tube Connectors

SR 6428

Nylon

- Male and female parts sold separately
- Both male and female parts screw together, the screw and nut tighten to hold in place
- Male connectors have a stainless steel bolt
- Female connectors have a stainless steel nut

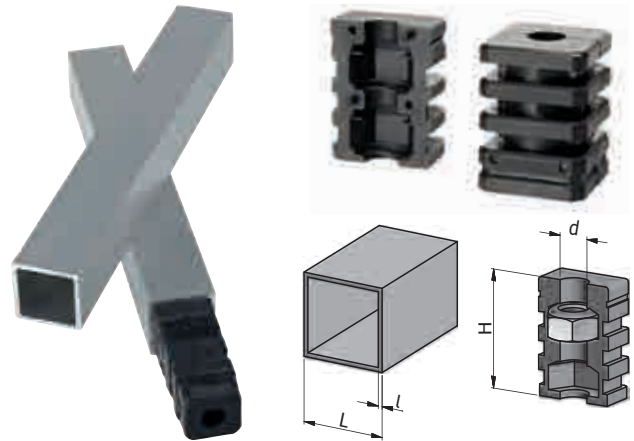

Female part (with nut)

Part Number	Dimensions (mm)			d	Standard Pack Quantity
	L	l (Gauge)	H		
550362	25	1.5	42	M8	300
550373	25	1.5	42	M10	200
551751	30	1.5	41	M8	500
551753	30	2.0	41	M8	250
550374	30	1.5	42	M10	150
550375	30	2.0	41	M10	150
550385	35	2.0	42	M10	150
550376	40	2.0	42	M10	150
551755	40	1.2	40	M12	100
551757	45	1.5	40	M10	100

Male part (with bolt)

Part Number	Dimensions (mm)			Thread Length	Thread Size	Standard Pack Quantity
	L	l (Gauge)	H			
550360	25	1.5	42	30	M8	300
550369	25	1.5	42	30	M10	200
551750	30	1.5	41	30	M8	250
551752	30	2.0	41	30	M8	250
550370	30	1.5	42	30	M10	150
550371	30	2.0	41	30	M10	150
550383	35	2.0	42	30	M10	150
550372	40	2.0	42	30	M10	150
551754	40	1.2	40	30	M12	100
551756	45	1.5	40	30	M10	100

Rectangular Expanding Tube Connectors

SR 6428

Nylon

- Male and female parts sold separately
- Both male and female parts screw together, the screw and nut tighten to hold in place
- Male connectors have a stainless steel bolt
- Female connectors have a stainless steel nut

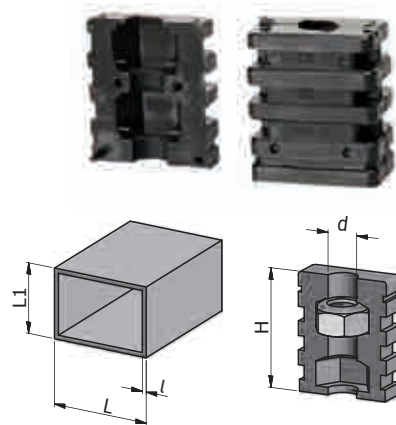

Female part (with nut)

Part Number	Dimensions (mm)			d	Standard Pack Quantity
	L x L1	l (Gauge)	H		
550394	30 x 20	1.5	41	M6	500
550403	30 x 20	1.5	41.5	M8	300
550404	40 x 20	1.5	42	M8	300
551768	40 x 25	1.5	42	M8	200
550424	40 x 25	2.0	42	M10	200
550425	50 x 25	2.0	37	M10	150
550426	50 x 30	2.0	38	M10	150

Male part (with bolt)

Part Number	Dimensions (mm)			Thread Length	Thread Size	Standard Pack Quantity
	L x L1	l (Gauge)	H			
550392	30 x 20	1.5	41	30	M6	500
550400	30 x 20	1.5	41.5	30	M8	300
550401	40 x 20	1.5	42	30	M8	300
551767	40 x 25	1.5	42	30	M8	300
550417	40 x 25	2.0	42	30	M10	200
550418	50 x 25	2.0	37	30	M10	150
550419	50 x 30	2.0	38	30	M10	150

FERRULES

Tapered Ferrules

SR 1520

PVC

- Choice of black or white
- Ideal as protective cap for protruding wire, steel rods or bars
- Give neat finish to tubular products
- Flexible for easy fitting

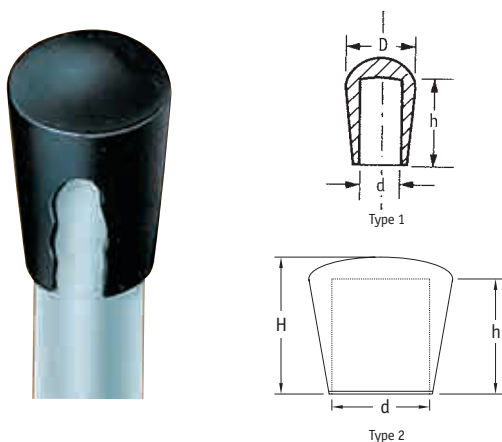

Type 1 (Imperial) - Black

Part Number	Dimensions						Standard Pack Quantity
	d		D		h		
	(ins)	(mm)	(ins)	(mm)	(ins)	(mm)	
50323	3/16	4.8	13/32	10.3	15/32	11.9	10000
50379	1/4	6.3	13/32	10.3	15/32	11.9	10000
12923	5/16	7.9	1/2	12.7	9/16	14.3	10000
60423*	5/16	7.9	33/64	15.5	29/32	20.0	5000
50978	3/8	9.5	13/32	15.1	5/8	15.8	2500
51110*	1/2	12.7	47/64	18.6	29/32	23.0	4000

*Low-density polyethylene.

Type 2 (Metric)

Part Number		Dimensions			Standard Pack Quantity
Black	White	d	H	h	
1251366	-	4.0	11.0	9.0	5000
1251379	-	5.0	13.0	10.0	5000
1251354	-	6.0	14.0	11.0	5000
1251362	1251363	8.0	16.0	13.0	5000
1251356	1251357	10.0	18.0	14.0	5000
1251364	1251365	12.0	21.0	17.0	3000
1251360	1251361	14.0	23.0	18.0	2000
1284230	1284231	16.0	25.0	20.0	2500
1251370	1251371	18.0	27.0	22.0	2000
1251352	-	20.0	30.0	24.0	1000
1251350	-	22.0	32.0	26.0	1000
1251358	1251359	25.0	36.0	30.0	750
1251376	1251378	28.0	38.0	32.0	500
1251374	-	30.0	41.0	34.0	500
1251368	1251369	32.0	43.0	39.0	400
1251372	-	35.0	47.0	40.0	250

Round Ferrules

SR 1510

LDPE

- Choice of black or white
- Gives neat finish to tubular products
- Gloss finish as standard

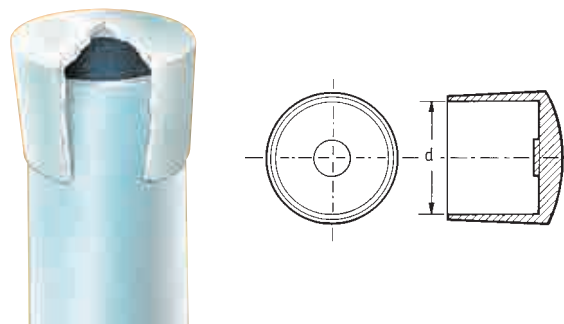

Imperial

Part Number		Dimensions		Standard Pack Quantity
Black	White	d		
		(ins)	(mm)	
51216	-	7/16	11.1	10000
10497	50829	1/2	12.7	10000
52047	52048	5/8	15.8	5000
10260	10258	3/4	19.0	4000
11761*	-	3/4	19.0	2500
10257	10256	7/8	22.2	2500
10265	10263	1	25.4	1500
50248	10519	1 1/16	26.9	600
12000	52001	1 1/8	28.6	1200
11143	12358	1 1/4	31.7	800
199124	-	1 3/8	34.9	1000
199050	-	1 1/2	38.1	500
199039	-	1 3/4	44.4	500
199205	-	2	50.8	300
199082	-	3	76.2	150

*Heavy-duty ferrule.

Metric

Part Number		Dimensions (mm)	Standard Pack Quantity
Black	White	d	
460843	-	15.0	2000
460844	460854	16.0	2500
465377	465374	18.0	2500
465373	600252	20.0	2000
460847	460857	22.0	2000
460848	460858	24.0	2000
465372	465483	25.0	2000
460850	460860	26.0	2000
465376	-	28.0	2000
465375	465371	30.0	1500

Tube Plug

SR6461

Black LDPE or PVC

- Strong yet flexible to fit in tube ends
- Neat finish through small collar
- Type 1 LDPE, Type 2 PVC

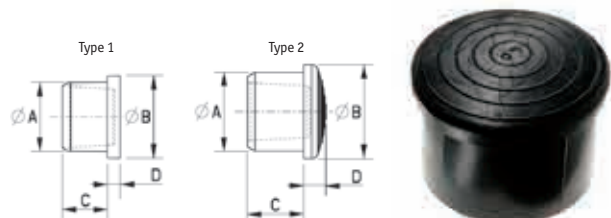

Part Number	Dimensions (mm)					Standard Pack Quantity
	A	B	C	D	Type	
045080022003	8	11	8	2.5	1	500
045100022003	10	13	8	2.5	1	500
045120022003	12	15	10	3	1	500
045130022003	13	16	10	3	1	500
045140022003	14	17	10	3	1	500
045150022003	15	18	10	3	1	500
045160022003	16	19	12	3.5	1	500
045170022003	17	20	12	3.5	1	500
045180022003	18	22	12	3.5	1	500
045190069907	19	25	20	6	2	100
045200069907	20	25	20	7	2	100
045210069907	21	26	20	7	2	100
045220011407	22	27	20	7	2	100
045230069907	23	29	20	7	2	100
045240069907	24	29	20	8	2	100
045250069907	25	30	20	8	2	100
045260069907	26	32	20	9	2	100
045270069907	27	31	20	9	2	100
045280011407	28	35	22	7	2	100
045290011407	29	36	22	7	2	50
045400069907	40	45	25	9	2	10

Square Ferrules

SR 1521

Black LDPE

- Ideal for popular sizes of square tubes

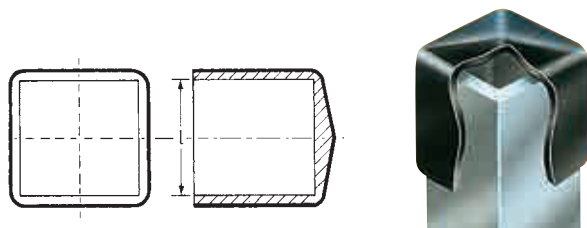

Part Number	Dimensions		Standard Pack Quantity
	(ins)	(mm)	
199019	¾	15.8	4000
10225	¾	19.0	3000
199257	¾	22.2	2000
199010	1	25.4	1000
199223	2	50.8	250

Oval Ferrule

SR 1522

Black PVC

- Provide neat finish to oval-shaped tubes
- Cover sharp tube edges
- Flexible and easy to fit

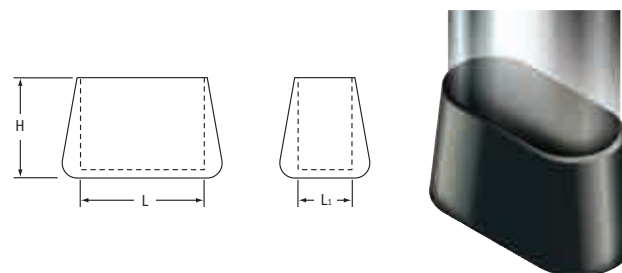

Part Number	Dimensions		Standard Pack Quantity
	L x L1	H	
465370	30 x 15	24.0	1500

Square Gloss Caps

SR 1523

Black Flexible PVC

- Ideal for finishing tubular products
- Flexible and easy to fit
- Give attractive gloss finish

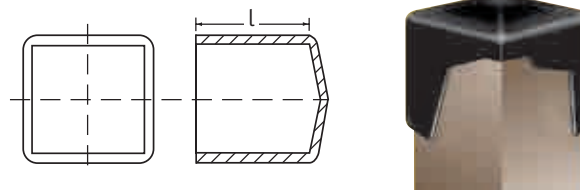

Part Number	Dimensions			Standard Pack Quantity
	D (mm)	D (ins)	L (mm)	
SQWA-0127-015	12.7	-	15.0	5000
SQWA-0159-015	16.0	¾	15.0	2500
SQWA-0190-015	19.0	¾	15.0	2500
SQWA-0200-015	20.0	-	15.0	5000
SQWA-0250-015	25.0	1	15.0	1250
SQWA-0127-025	12.7	-	25.0	4000
SQWA-0159-025	16.0	¾	25.0	2500
SQWA-0190-025	19.0	-	25.0	2000
SQWA-0200-025	20.0	-	25.0	1250
SQWA-0250-025	25.0	1	25.0	1000
SQWA-0300-025	30.0	-	25.0	1000
SQWA-0400-025	40.0	-	25.0	500
SQWA-0500-025	50.0	-	25.0	400
SQWA-0300-040	30.0	-	40.0	500
SQWA-0400-040	40.0	-	40.0	400
SQWA-0500-040	40.0	2	40.0	200

FERRULES

Heavy-Duty Round Ferrules

SR 1516

Black PVC

- Heavy-duty ferrule with flat thick base
- Ideal for protecting tubular products
- Thick base gives extra protection from rough edges

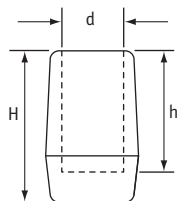

Part Number	Dimensions (mm)			Standard Pack Quantity
	d	H	h	
465365	10.0	28.0	22.0	2000
465367	12.0	31.0	24.0	2000
465366	16.0	36.0	29.0	1000
465369	18.0	38.0	31.0	1000
465368	20.0	40.0	33.0	750

Gloss End Tips

SR 1506

Flexible PVC

- Choice of black or white
- Durable high-gloss, smooth finish
- Ideal finish for product presentation and protection



Part Number		Dimensions (mm)		Standard Pack Quantity
Black	White	Internal Diameter	Internal Length	
DM0093-1/2A	-	2.4	13.0	5000
FCWA-0032-013	FCWB-0032-013	3.2	13.0	5000
FCWA-0040-013	FCWB-0040-013	4.0	13.0	5000
FCWA-0048-014	FCWB-0048-014	4.8	14.0	5000
FCWA-0060-010	FCWB-0060-010	6.0	10.0	5000
FCWA-0060-013	FCWB-0059-013	6.0	13.0	5000
FCWA-0064-013	FCWB-0064-013	6.4	13.0	5000
FCWA-0079-013	FCWB-0079-013	7.9	13.0	5000
FCWA-0095-013	FCWB-0095-013	9.5	13.0	5000

End Tips

SR 1500

PVC

- Choice of black or white
- Add protection or a neat finish to a wide range of applications

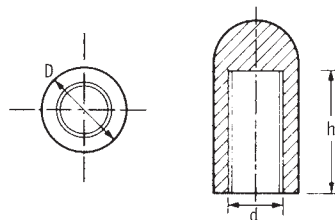

Part Number		Dimensions (mm)			Standard Pack Quantity
Black	White	d	H	h	
10461	50987	2.4	6.6	5.6	20000
11343	10395	2.7	12.2	6.3	20000
110476	110477	3.0	9.7	5.5	20000
12351	-	3.2	5.1	5.5	20000
11227	10393	3.2	14.2	7.0	20000
11794	61797	3.2	9.7	5.5	20000
12352	50256	4.0	13.3	6.2	20000
110593	110596	4.0	9.2	5.5	20000
10565	50288	4.8	14.2	7.0	20000
10870	12889	5.0	20.3	7.9	10000
199462	-	6.0	11.0	8.5	20000
10427	51237	6.3	15.5	8.7	10000
51033*	-	6.4	10.4	7.9	20000
12635*	-	6.4	13.2	9.5	10000
12888	10855	7.0	18.0	9.8	10000
10283	51378	7.6	17.0	11.0	10000
51320*	-	7.9	13.2	9.5	20000
12355	10384	8.0	24.2	10.5	10000
51114*	51297	9.5	13.3	11.1	15000

*Flat head

Hanger Caps

SR 1512

Black Flexible PVC

- Attractive caps with convenient hanger
- Flexible for easy fitting
- Weather resistant

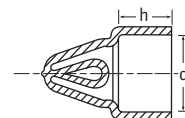

Part Number	Dimensions		h	Standard Pack Quantity
	d			
	(ins)	(mm)		
HCWA-0222-030	7/8	22.2	30	1000
HCWA-0254-030	1	25.4	30	1500

Ball End Caps

SR 1634

LDPE

- Heavy duty glide which enhances the leg design
- May also be used as a decorative top or finial
- Secure press fit



Part number	Dimensions (mm)		Dimensions (ins)		Standard Pack Quantity
	Diameter	Tube Size	Diameter	Tube Size	
BC010A	15.9	7.9	0.625	0.312	10000
BC015A	22.2	12.7	0.875	0.5	4300
BC020A	25.4	15.9	1	0.625	3000

Tube Adjusters with Thumb Screw

SR 1503

Nylon

- For fixing telescopic tubes in position

Part Number	To Fit Tube Size	Colour	Standard Pack Quantity
199510	5/8" & 3/4"	Natural	1000
199513	5/8" & 3/4"	Black	1000
199528	5/8" & 20mm	Natural	1000
199516	3/4" & 7/8"	Natural	1500
199519	3/4" & 7/8"	Black	1000
199522	1" & 7/8"	Natural	1000
199525	1" & 7/8"	Black	1000

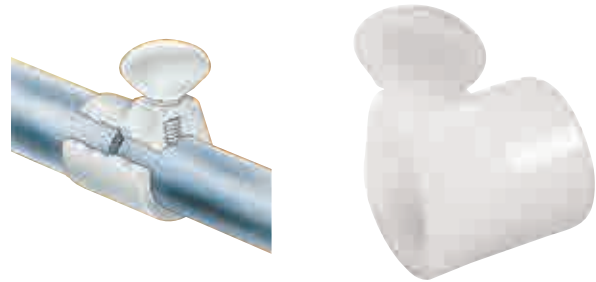

Anti-Rattle Rings

SR 1508

Black or Grey PVC

- Ideal for finishing telescopic tubes

Part Number		To Fit Tube Size	Standard Pack Quantity
Black	Grey		
199466	199467*	7/8" - 3/4"	1250
199452	199453	1" - 7/8"	2500

*Pack Qty = 2000



Tube Locks

SR 1508

Dark Grey Polypropylene

- Secure two telescopic tubes in place
- Metal pin provides additional strength
- Reusable
- Easy to install by drilling 1/4" hole through tube, to enable tube lock to snap into place

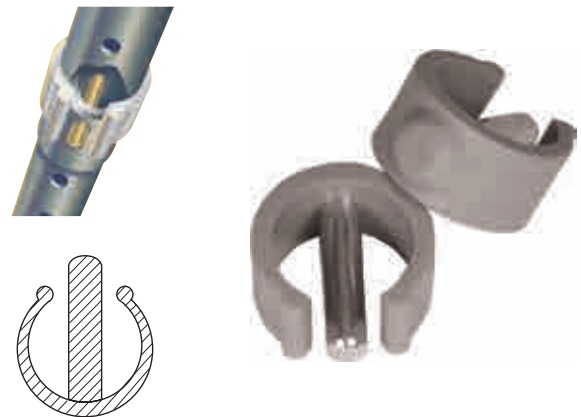

Part Number	To Fit Tube Size	To Fit Tube Size (mm)	Dimensions (mm)		Standard Pack Quantity
			Pin Diameter	Pin Length	
497452	3/4" - 7/8"	19.1 - 22.2	6	25	1000
497453	7/8" - 1"	22.2 - 25.4	6	28	1000